



Catalog 565-8

Vision® Air Handler – Extended Sizes

Models CAC/CAH 107G—169G

Sizes 107 through 169



Introduction	3	Ductwork	23
AHRI Certification	3	Piping and Drain Pan Traps	24
Agency Listed	3	Vibration Isolation	24
The Vision Air Handler Advantage	4	Sound	24
Daikin SelectTools Software Selection Program	9	Air Supply Systems and Fan Laws	24
Features and Benefits	10	Fan and Motor Heat	25
Vision's Unique Standard Features	10	Variable Frequency Drives	26
Customized Options:	12	Engineering and Physical Data	27
Component Types	14	Component and Section Weights	34
Fans	14	Fan Data	35
Air Handler Selection	21	Coil Data	36
Selecting Coils	21	Side Load Filter Data	37
Selecting Accessories	21	Technical Data	38
Selecting Fans	21	107 Extended Size Air Handling Unit	38
Quick Select Table	22	Electrical Data	46
Application Considerations	23	Supply Power Wiring	46
Installation Flexibility	23	Engineering Guide Specification	47
Mounting and Access	23		

AHRI Certification



Certified in accordance with the forced circulation air cooling and air heating coils certification program, which is based on AHRI Standard 410.



Standard and custom size units certified in accordance with the central station air handling units certification program, which is based on AHRI Standard 430.

Agency Listed



All standard units
All custom size units
All Canadian units

MEA
342-99-E

Labeled Vision units are tested and listed by ETL in accordance with UL 1995, Standard for Safety Heating and Cooling Equipment, and thereby fully comply with NFPA 90A material requirements.

Nomenclature

CAH 169 G D A C

Model

CAH = Custom modular air handler
CAC = Custom modular component

Nominal unit size

(nominal square foot of coil)
107, 124, 141, 160, 169

Daikin air handling unit series

Unit cross section

C = Standard unit cross section
M = Custom size cross section

Motor location

A = Motor along side of fan housing
D = Motor downstream of belt drive plenum fan
G = Motor downstream of direct drive plenum fan
H = Fan array
C = ECM Fan
N = No supply fan
B = Motor downstream of fan housing

Unit type/coil position

B = Blow-through cooling coil location
D = Draw-through cooling coil location
H = Heating only
V = Vent only

The Vision Air Handler Advantage

Flexibility	
Vision's unique design	What it can do for you
Custom-modular platform	Allows customizing of the system with a wide selection of components and sizes.
Variable Dimensioning™ design	Allows cabinet to be sized in two-inch increments (height and width) to meet installation or aesthetic requirements.
Ships assembled or by section	Minimizes install time; reduces installation cost; and allows passage through doors, tight spaces, and in elevators (great for retrofit jobs).
Multiple coil, fan and filter selections	Allows optimum selections for cost, energy efficiency, performance, indoor air quality, and low noise.
Wide selection of base rail heights (8"min. to 12")	Allows for condensate trapping, eliminates need for costly housekeeping pad, and provides space required between condensate connection and traps on steam applications.
Painted cabinet	Enhances exterior appearance for units in visible locations.
Indoor Air Quality	
Vision's unique design	What it can do for you
Low-leakage cabinet construction Standard Cabinet: less than 0.5 CFM/ft ² of cabinetry at design static up to +5/-6" w.c. High Pressure Cabinet: less than Class 6 leakage or 1% supply air volume at design static up to +/-8" w.c.	Minimizes air leakage, noise and unfiltered air.
Double sloped stainless steel drain pan.	Inhibits bacterial growth; eliminates standing water that can support bacteria.
Double-wall, foam injected construction	Eliminates fiberglass fibers eroding into the air stream.
Multiple filter types (flat, bag and cartridge) with side-load and front-load capabilities	Gives full range of filter efficiencies, final filter arrangements, and filter section depth flexibility.
Hinged access doors with full-grip handles	Allows for easy inspection and cleaning of drain pans; promotes regular inspections.
Patented splice collar	Prevents unfiltered, unconditioned air from entering the system. Allows for leak-resistant section to section joining in the field.
Easy-to-remove access panels	Allows for easy inspection and cleaning of drain pans; promotes regular inspections.

Operating Efficiency	
Vision's unique design	What it can do for you
The low air-leakage cabinet design, all inside and outside panel penetrations are sealed	Increases operating efficiency; reduces energy loss and operating costs.
Patented gasketed frame channels	Minimizes direct exposure of metal to metal in cabinet framework to reduce cold bridging and condensate collection; lowers operating costs.
Fan selection options (housed forward curve or airfoil, belt-drive or direct-drive plenum, inline, twin, and ECM fans)	Results in lowest possible BHP requirements.
Patented UltraSeal™ low-leak dampers	Maximizes operating efficiency; reduces operating cost.
Double wall liners with injected foam insulation	R-13 insulation value reduces condensation and improves operating efficiency.
Easy, Low Cost Installation	
Vision's unique design	What it can do for you
Ships assembled or by section	Minimizes install time, reduces installation cost; allows passage through doors, tight spaces and in elevators (ideal for retrofit jobs).
Complete disassembly	Allows for complete knock down during installation if required for tight fit applications.
Patented section splicing	Saves installation time; creates an airtight environment.
Extended coil connections with gasketed airseal, external drains and vents	Eliminates need to remove panels for connection during installation; preserves air-tight environment; saves time and cost.
Bolted frame construction with removable panels	Provides complete accessibility to unit components.
Fan system factory tested and balanced	Saves time during installation and promotes proper operation.
Discharge or inlet plenum sections	Adapts easily to ductwork and provides a turning section for stacked components.
Easy Maintenance and Serviceability	
Vision's unique design	What it can do for you
Direct-drive plenum fans	No fan bearings, belts or drives to replace or maintain.
Removable cross-member frame channels	Allows for top or side coil removal without disrupting unit integrity.
Extended fan bearing lube lines	Makes lubricating fan system easier.
Extended coil drain connections	Reduces coil venting time; helps coil condensate drain completely.
Hinged access doors with full-grip handles	Allows for proper inspection.

Quality

Daikin air handling equipment has been respected and regarded as high quality for nearly 60 years. Daikin has taken a major step in redefining the indoor air handler with the Vision air handler. Demands for improved indoor air quality, low sound, high operating efficiency and smaller mechanical rooms require a better product for today's air handler market. The Daikin Vision air handler is designed to meet or exceed these demands.

The key to providing such a high quality product is in the basic design. The Daikin Vision air handler's patented construction provides unequaled thermal efficiencies and low leak rates. In addition, Vision air handlers offer tremendous flexibility in sizing, component options, and unit arrangements to meet the indoor air quality, operating efficiency, sound and installation requirements for today's extensive commercial and custom markets.

Flexibility

By virtue of its unique frame design, the Daikin Vision air handler offers tremendous flexibility. This flexibility is reflected in our unique Variable Dimensioning™ feature that allows units to be sized in two-inch increments (in height) and four-inch increments (in width) to fit the available space. Numerous section and component options, and the ability to arrange components in whatever arrangement is required, allow Vision air handlers to be customized to the requirements of each job, without expensive field modifications.

Finally, Vision air handlers can be shipped as a completely assembled unit, in modules or by component sections for new or retrofit applications that require smaller sections for passage through the building.

Cabinet Construction

Daikin Vision air handler cabinetry consists of a box-type frame channel—the backbone of the unit—and easy-to-remove panels or hinged access doors. The unique, patented frame channel design allows three identical pieces to be bolted together to form a corner of the unit. Channel material is G90 unpainted galvanized steel (optional—painted G60 galvanized steel) with neoprene gasketing on all flanges to minimize leakage. Gasketing is also factory applied at all contact surfaces between interior and exterior metal components to minimize thermal bridging. See [Figure 1](#).

Panels are secured to the unit with fasteners that can be easily removed to access the unit interior. The frame channel and panels are easily disassembled and reassembled, giving contractors tremendous flexibility in installing and servicing the units—even where space is limited—saving time and money. Patented splice joints ([Figure 2](#)) help guide sections together for a tight fit, saving additional time and money on installation.

Figure 1: Patented Gasketed Frame Channel

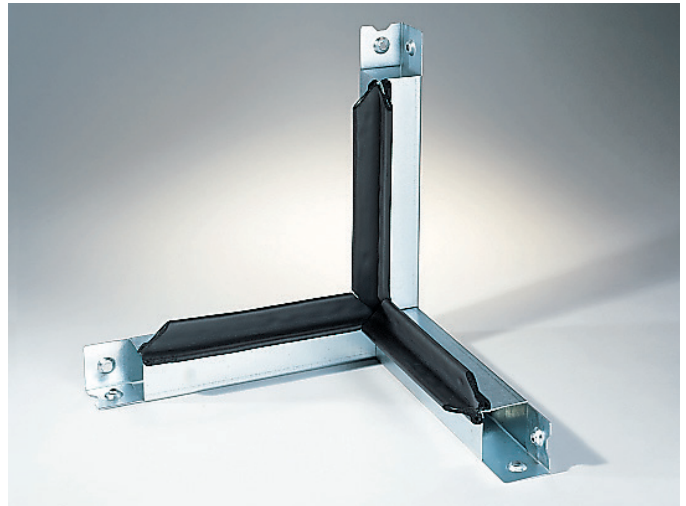

Standard Cabinet

This unique cabinet design results in air tight, thermally efficient units, which translates into energy savings over the life of the unit. Vision air handlers are capable of casing leakage rates that shall not exceed 0.50 CFM per square foot of casing surface area a design static pressure up to a maximum of +5" w.c. in positive pressure sections and -6" w.c. in negative pressure sections.

High Pressure Cabinet

The high pressure air handler construction utilizes laser welding technology to provide stronger frame channels and new gaskets to reduce the standard leakage rate to a casing leakage rate that shall not exceed ASHRAE 111 Class 6 or be no more than 1% of the supply air volume at design static pressure up to a maximum of +8" w.c. in positive pressure sections and -8" w.c. in negative pressure sections, where casing leakage (CFM/100 ft² of casing surface area) = $C_L \times P^{0.65}$. The high pressure air handler construction maintains the unique flexibility, ease of installation and serviceability that Vision has had for years while providing best-in-class air sealing.

ASHRAE 111 is the test standard to test duct leakage. The standard uses a class system to indicate relative leakage rates. These class levels are dependent on static pressure and surface area. The formula for leak class is:

$$C_L = \frac{F}{P^{0.65}}$$

where $F = \frac{\text{Leakage in CFM}}{100 \text{ ft}^2 \text{ Cabinet Surface Area}}$ and $P = \text{Static pressure in inches w.c.}$

To prove this construction works, full unit factory witness testing will be available for purchase.

Vision air handler panels use the latest technology to provide the lowest deflection, lightest weight and most importantly, the most thermally efficient 2-inch thick panel system available. R-13 insulation quality injected-foam is thermally pressed between inner and outer liners yielding an extremely rigid panel. The inner liner comes standard with galvanized steel or optional stainless steel. The outer liner standard is galvanized steel with options of pre-painted, or pre-painted heavy-gauge, galvanized steel.

Base rails are provided, ranging from 8" to 12" and can eliminate the need for a housekeeping pad—saving time and money on installation. A full perimeter base rail per shipping section is factory assembled.

Figure 2: Patented Splice Joint for Section-to-Section Joining



Access and Serviceability

Equipment must be designed to perform efficiently and withstand the wear and tear of everyday use. It must be designed to provide easy access to interior components for routine maintenance and service to maintain peak performance. The patented frame channels and easy-to-remove panels or hinged access doors of the Vision air handler cabinet provide complete access to the unit interior and components. Components, including the fan and coil assembly, can be removed through the side of the unit, top of the unit, or a combination of both, which reduces required service clearances (Figure 3). Coil removal does not require access to the non-connection end of the coil. A unique coil tie down method simplifies coil removal and replacement.

Figure 3: Panel/Channel Removal for Access

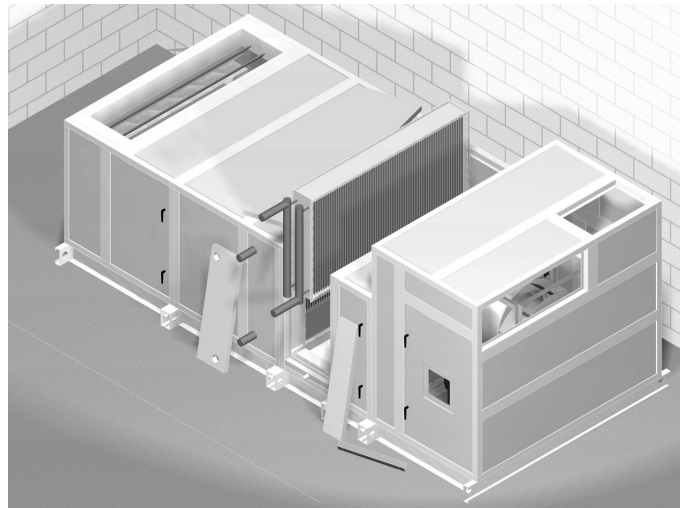

Daikin SelectTools Software Selection Program

Because the Daikin Vision air handler is so flexible and has so many different component types, there virtually are an infinite number of possible unit arrangements. To help the customer easily define their product requirements, Daikin provides a user-friendly software selection program, called Daikin SelectTools.

This program configures and sizes both standard and custom units. Components can be selected in minutes. This Windows® based program leads the user through the selection process by prompting for pertinent input data for all components required. Component sections are selected by placing them on a configuration screen. Once the unit layout is defined, the options and accessories are identified.

The program gives immediate feedback regarding fan and coil selection, offering a choice of many different options based on the performance inputs. Once final component selections have been made, the program provides all output needed for specification and submittal purposes, including fan curves, coil performance psychometric charts, weights, dimensional drawings, and a unit specification. A fully detailed DXF file is also available.

Daikin SelectTools is a comprehensive, efficient and user-friendly software selection program (see [Technical Data on page 38](#) for examples of the output).

Vision's Unique Standard Features

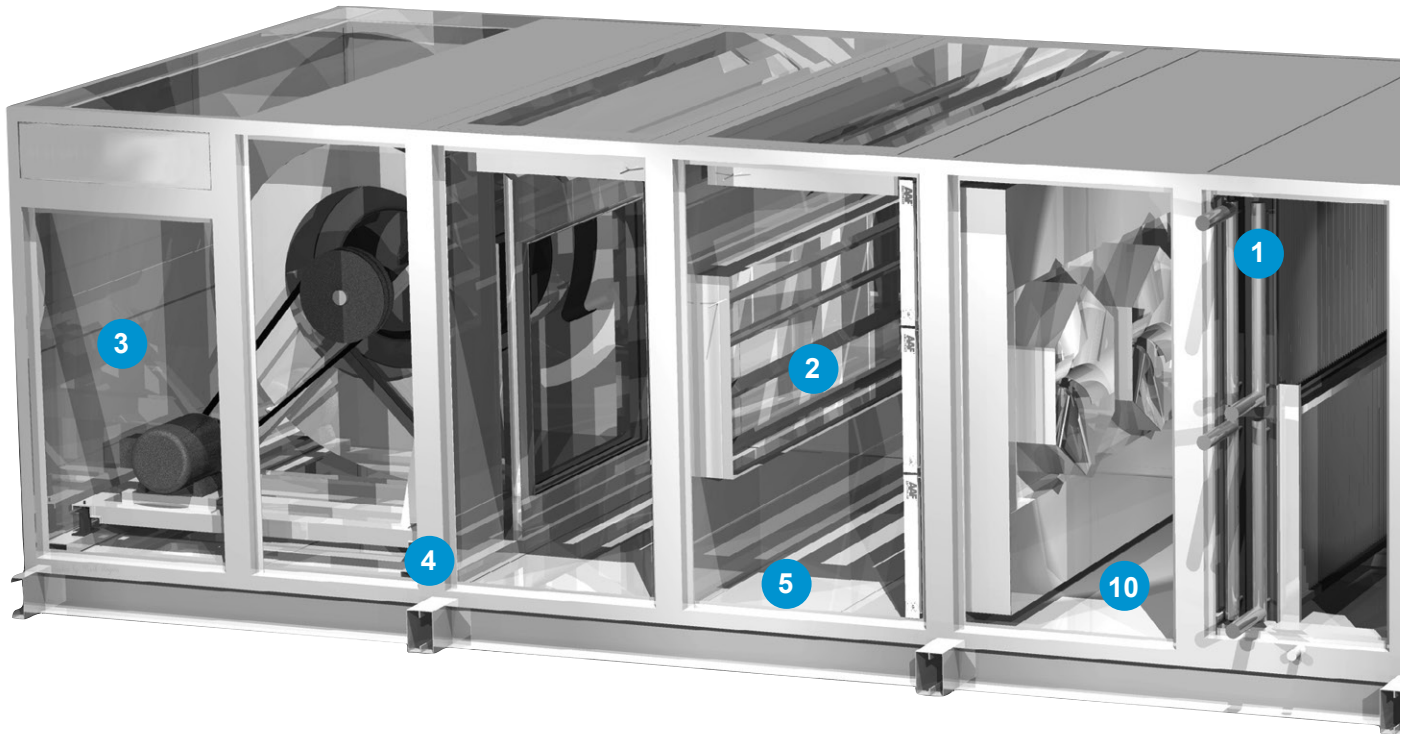

1 Extended Coil Connections

- Reduces installation costs
- Reduces maintenance time
- Aids proper drainage
- Grommet seal reduces leakage



2 Patented UltraSeal™ Low-Leak Dampers

- Help maximize operating efficiency
- Reduces operating cost



3 Rugged Cabinet Enclosure

- Rigid, thermal efficient (R-13) injected-foam panels are strong and lightweight
- Promotes longer unit life

4 Gasketed Frame Channel

- Eliminates metal-to-metal contact between paneling and framework
- Minimizes cabinet condensate and corrosion
- Facilitates top and side component removal
- Promotes long life

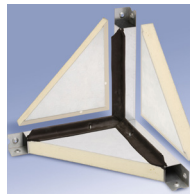

5 Smooth Interior Surface

- Reduces dirt accumulation
- Facilitates cleaning
- Helps improve IAQ



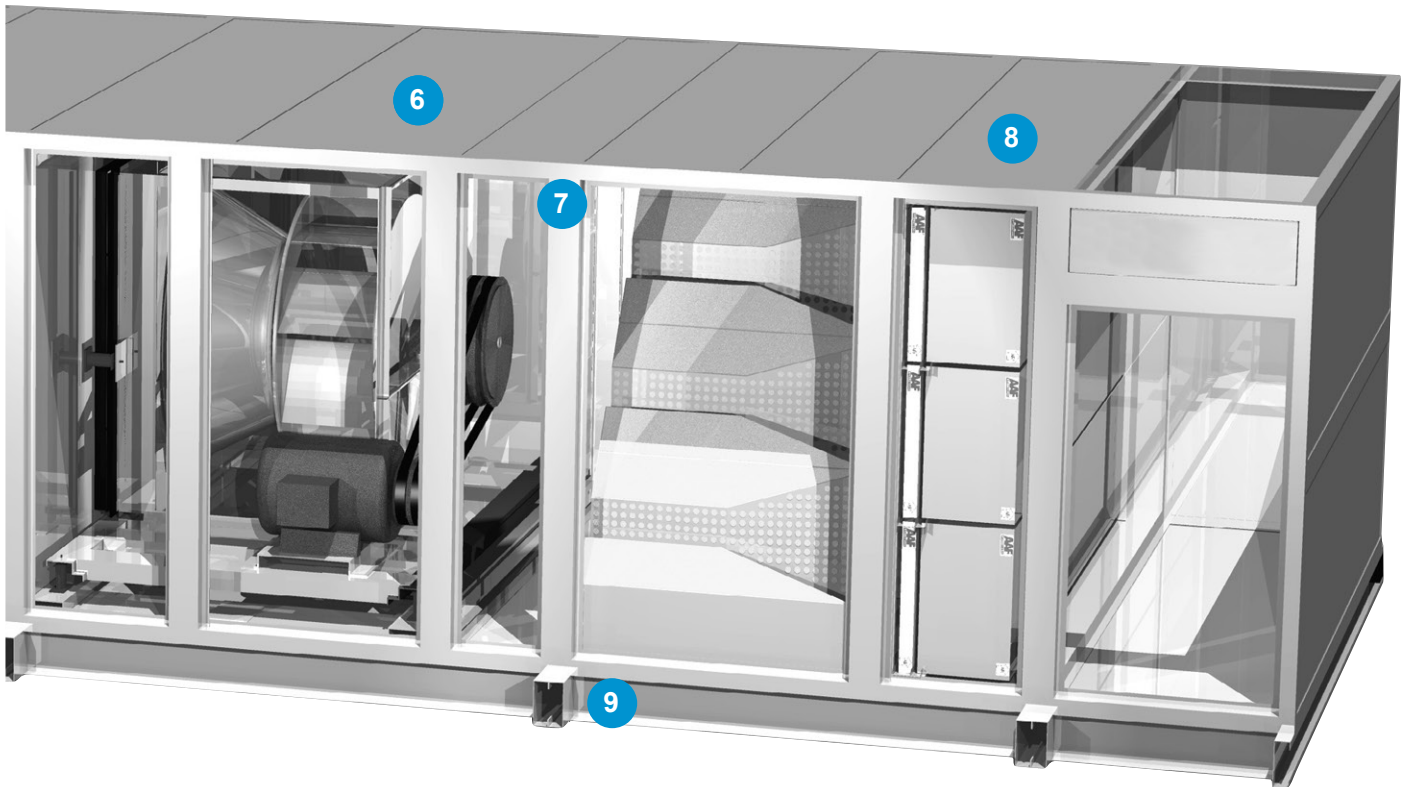

6 Custom-Modular design

- Allows custom selection and configuration of components
- Allows design of system to meet space and performance requirements

7 Patented Splice Collar

- Reduces installation cost
- Creates an airtight environment



8 Frame Channel Disassembly

- Allows two-sided access
- Easier, faster service and maintenance



9 Variable Height Base Rails (8" to 12")

- Eliminates costly housekeeping pad
- Allows for condensate trapping

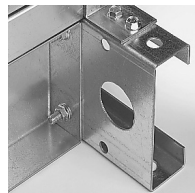

10 Visible Double-Sloped Drain Pan

- Makes inspection and cleaning easier
- Helps improve IAQ



Customized Options:

- Variable Dimensioning™ feature for flexible cabinet sizing on 2" increments (height) and 4" increments (width)
- Galvanized or painted cabinet
- Multiple section depths
- Variable base rail heights (8" to 12")
- Various casing and drain pan materials
- Mixing boxes/economizers
- Sound attenuators
- Integral face and bypass dampers
- Blenders and air mixers
- Multiple coil section depths
- Multiple blower options including housed airfoil, belt- or direct-drive plenum, dual plenum and fan array
- Filters (flat, bag and cartridge) available in side load and/or front-loading configuration
- HEPA filters in final filter location
- Gas-phase filtration
- Flush-mounted filter gauges
- Starters and inverters (VFDs)
- Disconnect switches
- Ultra-violet lights
- Inward opening doors
- Windows, doors, marine lights and receptacles
- Manual selections to accommodate special components
- Flexibility in shipping arrangements
- Digital Ready™ control components
- Humidifier manifold

Fan Options

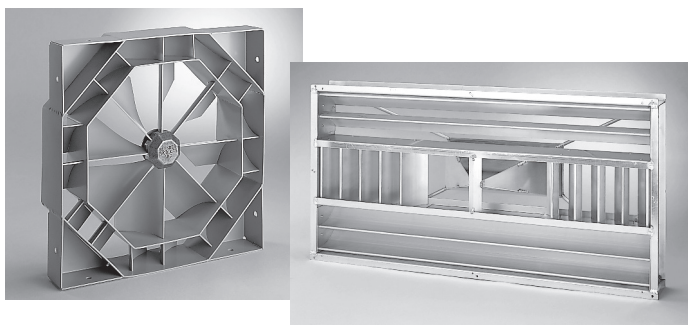
Filter Options

Blender/Air Mixer Options

Filter Gauges

RETURN/ EXHAUST	ECONOMIZER	BLENDER	FILTER	F & BP DAMPER	COIL	ACCESS	HORIZONTAL COIL	SUPPLY FAN	DIFFUSER	COIL BLOW THRU	ACCESS	FILTER	ATTENUATOR	PLENUM
PLENUM FAN			2" & 4" ANGULAR	INTERNAL	HORIZ HEATING	LARGE	CLG. / HTG. COMBINATION	AF FAN		HORIZ		CARTRIDGE		DISCHARGE PLENUM
AF FAN	INLET PLENUM		2" & 4" FLAT	INTEGRAL	1 & 2 ROW STEAM AND 1 - 4 ROW WATER	MEDIUM	CLG. 10 ROW	PLENUM FAN		CLG. OR HTG.		BAG		
	MIXBOX WITH 4" FILTER		CARTRIDGE	EXTERNAL		SMALL	4 ROW							
MIXING BOX	MIXBOX WITH 2" FILTER		BAG	RIGHT ANGLE			SFA COIL MFA COIL F & BP							



Sound Attenuators



Marine Lights and Accessories

Fans

Fan types available with the Daikin Vision air handling units are housed double width, double inlet (DWDI) forward curved and airfoil fans, plenum fans, inline fans, twin fans and fan array. Forward curved fans generally provide the lowest first cost option and are used for lower static pressure applications.

DWDI Housed Fans

Daikin housed forward curved fans will typically operate up to 6.0" of static pressure. Airfoil fans have a higher first cost, but are more efficient, quieter and can handle higher static pressures. Daikin housed airfoil fans will operate up to 9.0" of static pressure.

Plenum Fans

Plenum fans (Figure 4) save space by eliminating turns in ductwork. They also provide a high degree of flexibility when locating the outlet ductwork. Plenum fans are also very good for blow-through applications as they generate a uniform outlet velocity profile. Both belt drive and direct drive plenum fans are available.

Direct drive plenum fans offer easier maintenance as they do not have fan bearings, sheaves, or belts.

Figure 4: Plenum Fan



Table 1: Belt-drive Dual Fan Width Requirements

Fan Size	Dual Fan Minimum Cabinet Width (in.)	Minimum Standard Unit Cabinet Size
27	148	107
30	156	107
33	176	124-141
36	184	124-141
40	196	160
44	212	160
49	224	169

Table 2: Direct-drive Dual Fan Width Requirements

Direct-drive Plenum Fan Size	Dual Fan Minimum Cabinet Width (in.)	Minimum Standard Unit Cabinet Size
40	152	107
44	164	107

Dual Fans

Direct drive plenum fans come with the optional dual arrangement. The multi-fan sets will provide more even air flow and redundancy if one fan should need servicing.

For redundancy, the rule of thumb is that one fan will provide approximately 65% of the total CFM provided by both fans if the remaining fan is not sped up. If more redundancy is required, then a VFD and larger motor can be used to speed up the single fan to achieve more airflow. The selection software will calculate the redundancy. If a manual calculation is required to calculate the maximum available airflow from the single fan, manually plot the single fan performance onto the dual fan curve as in See Figure 7. Extend the single fan rpm line to intersect with the system static pressure line. This balance point shows the performance of a single fan when one fails.

If a VFD is used, the fan can be sped up to the limit of the HP of the motor to get more airflow. To increase redundancy, a larger motor can be selected. Remember that over sized fan motors may be less efficient. This typically occurs below 50- 60% design bhp. If you over size the motor to increase redundancy, as the motor BHP drops farther away from the actual HP, the motor will run less and less efficiently. So, if the application is meant for dual fans, it may be best to simply use the best selection for efficiency and utilize what redundancy comes with this selection. This will ensure the customer will have the most efficient operating setup while having the insurance of good redundancy.

The width of the fans will determine which cabinets will allow certain fans. Table 1 & Table 2 will help by showing what minimum cabinet width and unit size you will need for specific fan diameter selections.

An optional motor removal gantry system is available for the Dual Plenum Fan and Fan Array options. The gantry option provides easier serviceability of motors if access is not available on both sides of the fan section.

The different types of fans are available in numerous wheel diameters per unit size. The fan size selection is always optimized and identified by the SelectTools software. The program considers performance, efficiency, sound generation and first cost and offers a number of fan sizes to select from. Fan and motor assemblies are provided with 2" spring isolators. All fans are dynamically balanced at the plant as an assembly, including the motors and drives.

All belt drive fans rotate on a solid steel shaft of uniform diameter that has been ground, polished, and coated with a rust inhibitor. Fan shafts are selected to have a maximum operating speed well below the first critical speed. Belt guards are available.

The fan bearings have a minimum L50 life of 200,000 hours, and are available as high as one million hours. Bearings are selected for minimum noise levels and minimal service. Bearings are self-aligning and pre-lubricated for immediate use. Bearings are mounted on rigid frames and positioned to provide proper balance. All bearings include copper lubrication lines that are extended to the access side of the fan cabinet with the grease fittings located near the access door opening.

All fan motors are internally mounted. The appropriate motor size will be selected by the SelectTools software. Motors cannot be undersized, but may be oversized if desired. Motor options include open drip proof, totally enclosed fan cooled, 1 speed/1 winding, 2 speed/1 winding, and 2 speed/2 winding. All single-speed motors are standard as premium efficiency, while 2-speed motors are high efficiency.

The fan array section has fan diameters from 12–33 inches, with arrangements of up to 12 fans. Daikin offers three motor control options to meet the highest level of redundancy. The array can be selected with a single VFD, a VFD per row or a VFD per fan. Each fan will come with an individual motor starter and backdraft prevention allowing complete isolation of any fan.

Figure 5: Spring Isolation

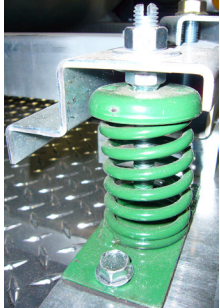

Fan Array

The fan array section will decrease the fan section length by using multiple smaller direct-drive fans. With the stacked array, the fans will also provide a more even airflow pattern throughout the unit and will allow the fans to be placed closer to the coil. Multiple fans also provide redundancy, allowing the system to deliver full airflow and static pressure if a fan or motor is lost. All fans in the fan array are direct-drive and offer more efficient performance with no belt losses and no required shaft bearing maintenance.

The fan array section has fan diameters from 12–33 inches, with arrangements of up to 24 fans. Daikin offers three motor control options to meet the highest level of redundancy. The array can be selected with a single VFD, a VFD per row or a VFD per fan. Each fan will come with an individual motor starter and backdraft prevention allowing complete isolation of any fan.

The ECM fan array section has a brushless, permanent magnet motor(s) for maximum efficiency. The inverter is integral to the motor. Each fan will come with an individual motor starter to allow for electrical isolation of each motor.

Figure 6: Fan Array Options

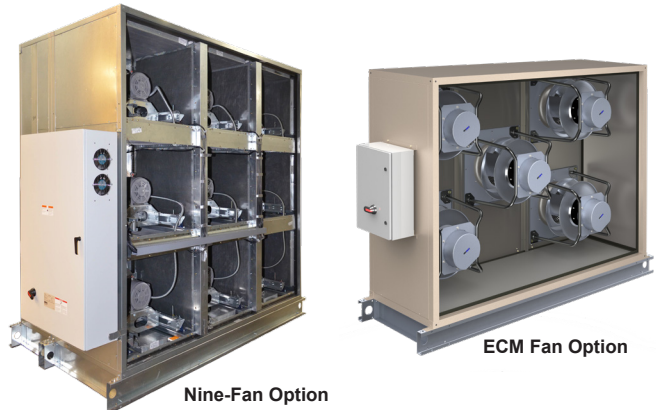
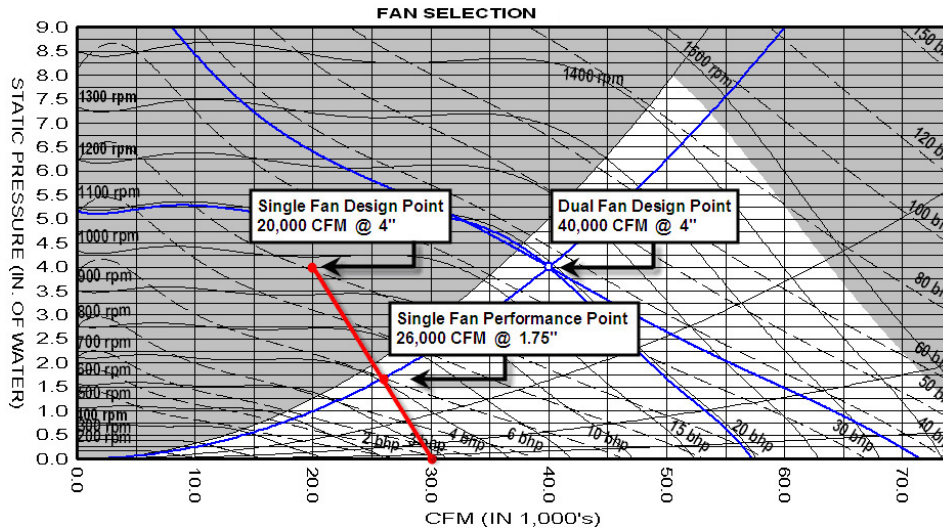

Figure 7: Dual Fan Redundancy – 65% if one fan fails



Coils

The Daikin Vision air handler offers broad application flexibility in coil sections and coils. Coils can be arranged in draw-through or blow-through configurations. Heating only, cooling only, or cooling and heating sections are available. All coils are installed with space between each coil to allow access for cleaning and mounting of controls.

Cooling coil sections, and cooling and heating coil sections, are available in seven different section lengths to accommodate every application requirement. Drain pans are center split with drain connections on each side. For drain connections (same end connections also available), field piping can be run under the unit, between the base rails. Removable access panels or doors may be provided in the deeper sections that will not interfere with piping connections extending through the unit side panels.

All cooling coils are mounted over a double sloped drain pan. The cooling coil rests on coil supports located over the drain pan. The drain pan extends beyond the leaving side of the coil to help recover condensate. The primary drain pan also extends under the coil headers and return bends to help remove condensate from the unit. A full thickness of insulation is always provided between the drain pan and the bottom outer panel. The drain pan is sloped in two planes to promote proper condensate removal.

Coil connections are grommet sealed inside and outside to ensure low cabinet leakage, and the connections always extend through the unit cabinetry, allowing for the easy connection of valves and piping (Figure 9). Water coil vents and drains are located outside the cabinetry.

Coils are available in two face area sizes, including medium and large.

With Daikin being a major manufacturer of heat transfer coils, the coil options are virtually unlimited. The Daikin contractor coil line has several coil types, ranging from hot and cold water, refrigerant and steam. Standard Daikin coils are AHRI certified. In addition to a broad range of circuitings, fin spacing and row depths, coils can be constructed of different material types for fins, tubes, connections, and casings. This provides the ability to specify a coil to meet the application requirements.

For more information on Daikin coils, consult the following catalogs:

- Cooling—water/refrigerant Catalog 411
- Heating—water/booster Catalog 412
- Steam—standard/distributing Catalog 413

Figure 8: Coil Connections, Vents, Drains, and Drain Pan Connection, Extend Through Unit Cabinetry



Filters

The Daikin Vision air handler is designed to house flat, bag or cartridge filters. These media types range in efficiencies up to 95% and MERV 15. (See page 17 for a description of the MERV Rating.) In addition to offering a full range of efficiencies, the filter media can be provided with an optional antimicrobial treatment. Antimicrobial treatments are highly recommended for a complete filtration system.

An optional filter pressure gauge may be ordered with each filter section to help promote regular servicing and prevent clogging.

Both bag and cartridge filters have a pre-filter and can be either side load or front load. An access door is provided on either side or both sides of the unit to access the filter section. Filters can be positioned any place in the unit, and as many filter sections as required can be used. Many health and food industries require stringent filtration. Often, a filter section must be the last component in the air stream.

The Daikin Vision air handler meets these requirements by providing a filter section located as the last component in the air stream, and with full sheet metal liners.

Figure 9: Filter Particle Size Chart (in microns)

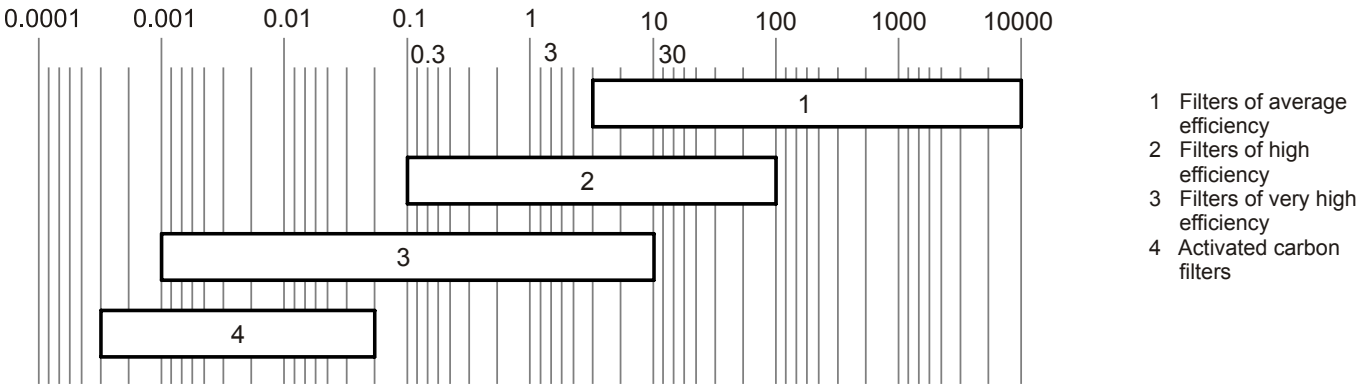
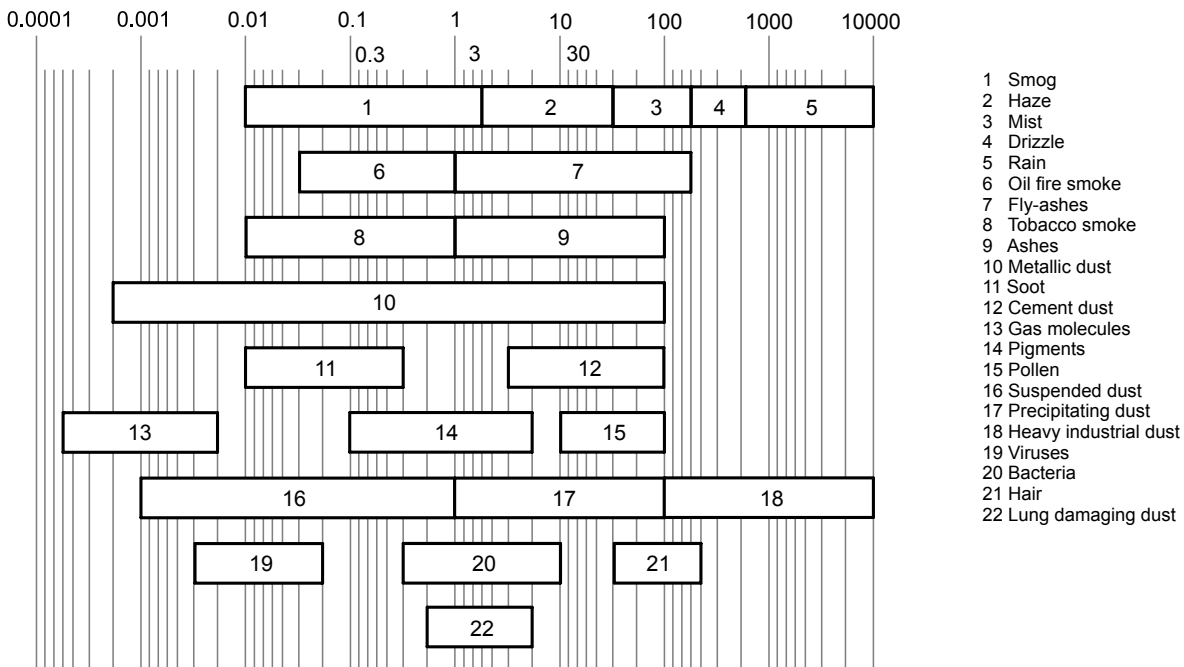

Figure 10: Pollutant Particle Size Chart (in microns)



What is the MERV Rating?

Minimum Efficiency Reporting Value (MERV)—ASHRAE Standard 52.2-1999 entitled “Method of Testing General Ventilation Air-Cleaning Devices for Removal by Particle Size” provides a methodology for determining filter efficiency at removing various sizes of particles (see Figure 9) as the filters become loaded. There are three ranges of particle sizes that define the MERV value:

Range 1—0.3 to 1.0 .m particle size.

Range 2—1.0 to 3.0 .m particle size.

Range 3—3.0 to 10.0 .m particle size.

The Table 3 shows a comparison of the MERV rating to the average arrestance percentage by the older ASHRAE Standard 52.1 method:

Table 3: MERV Rating vs. AHSRAE Standard 52.1

Standard 52.2 (MERV)	Approx. standard 52.1		Particle size range
	Dust spot efficiency	Arrestance	
15	>95%	n/a	1
14	90 to 95%	>98%	1
11	60 to 65%	>95%	2
8	30 to 35%	>90%	3
6	<20%	85 to 90%	3

Standard Filter Types Available:

- MERV 8 – 2" or 4" depth. Pleated filter with two layers of added polypropylene laminate to increase efficiency.
- MERV 13 – 2" or 4" depth without 1" track.
- MERV 14, 13, and 11 – 4" depth, 1" track requirement. Mini pleated filters with metal cell sides and headers that provide superior moisture resistance.
- MERV 14, 13, and 11 – 12" depth, 1" track requirement. Steel interlocked header and cell sides hold the corrugated aluminum separated pleats allowing optimum airflow. Rated UL Class 1.
- MERV 14, 13, and 11 – 12" depth, 1" track requirement. Mini pleats held in a V-bank configuration providing greater airflow capacity and longer service.
- MERV 15, 14 and 12 – 36", 30" and 22" depths, 1" track requirement. Extended surface pockets made from high-loft, layered synthetic media. Rated UL Class 1 MERV 8 efficiency filters also available in 19", 15" and 12" depths.
- HEPA (MERV 17)
 - 99.99% – 0.3 mm (HEPA)
 - 99.999% – 0.3 mm (ULPA)
 - 99.99995% – 0.1 to 0.2 mm (ULPA)

Ultraviolet Light Options

Vision air handlers can be factory equipped with ultraviolet (UV) light options that are pre-engineered for placement to provide maximum effectiveness. Two UV light options are available. The first can be mounted on the downstream side of all cooling coils and above the unit drain pan for surface "kill" applications to comply with the GSA Facilities Standard for federal buildings. The second can be mounted in the air stream prior to filter(s) for "kill on the fly" applications. Both applications are agency approved to UL Category Code ABQK specification, HVAC Accessories, Air Duct Mounted, in addition to the ETL listing of Vision air handlers.

Access

Access sections can be selected to meet specific application criteria. They can be placed anywhere in a unit in a variety of depths and are available in depths of 16" – 54". Typically, access sections are used for field-installed components, air monitoring devices, or to provide ample space between components.

Mixing Boxes and Economizers

When outside and return air mixing is required, either a mixing box or an economizer section can be selected. Either component will regulate the amount of outside and return air supplied to the conditioned space. The mixing box or economizer can make use of free cooling by opening outside air dampers when the ambient air will help to condition the supply air stream. Additionally, dampers may be individually sized to provide better mixing.

Both the mixing box and economizer are provided with a Daikin UltraSeal™ low leak damper. This damper has one of the lowest leakage rates in the industry, maximizing energy efficiency. At 4.0" static pressure and a face velocity of 1100 fpm through the dampers, the leakage rate is less than 0.2% (it is common to specify leakage rates at higher static pressures, but dampers should not exceed 2" of static pressure). The parallel airfoil blades are hollow core and fully gasketed. Continuous vinyl seals are provided between the damper blades. Stainless steel end seals and linkage built into high strength ABS plastic endcaps provide smooth, quiet operation.

Face and Bypass Dampers

Face and bypass dampers can be provided to modulate temperature by bypassing air around the coil. The opposed blades meter varying air volumes through the coil and bypass to attain the final air temperature demanded. Daikin Vision air handlers offer only low leak dampers in their face and bypass sections.

Three styles of face and bypass sections are available.

- Internal bypass is available for use with medium face area coils (Figure 12).
- External bypass and external right angle are used when larger face area coils are required. The damper blades are fabricated of continuous galvanized steel with the damper rods rotating in nylon bushings. Damper shaft extensions are supplied to facilitate damper motor location.
- Integral face and bypass. Vision air handlers are pre-engineered to provide an accurate, reliable method of preheating and tempering air in standard or make-up air applications. Integral face and bypass coils maintain constant steam pressure or tube velocities through the coil to help prevent freeze-ups, while varying airflow through the coil using bypass dampers. The amount of air bypassed or heated is determined by a preset leaving air temperature. It can vary from the bypass dampers being fully closed (all air passes through the coil) for maximum heat output, to the bypass dampers being fully open (no air passes through the coil) for minimum heat output. The air is then mixed at the discharge of the coil to achieve the desired leaving air temperature. Air pressure drop is maintained constant regardless of the position of the dampers.

Blenders/Air Mixers

Stratification can occur from the mixing box when airflow from two different temperature air streams do not mix completely. This incomplete mixing can continue through the air handler and subject an unprotected coil (no glycol) to freezing temperatures, damaging the coil. With the increased minimum outdoor air requirements as identified by ASHRAE Standard 62, the likelihood for air stratification increases. An air handler must be able to handle the required amount of outdoor air, regardless of temperature, without risking damage to the coil.

Blenders/air mixers help to provide protection for coils against freeze-up due to stratification. They add additional turbulence to the passing air streams, boosting the air velocity for improved mixing. Proper distance is provided immediately downstream to give the air streams enough time to fully mix before reaching the next air handler component. Because blenders/air mixers are static devices, they require no maintenance. Different blender/air mixer lengths can be selected to satisfy either the acoustic, space, pressure drop, or initial cost requirements.

The Daikin SelectTools software can help select the appropriate blender/air mixer for the application.

Figure 11: Blender

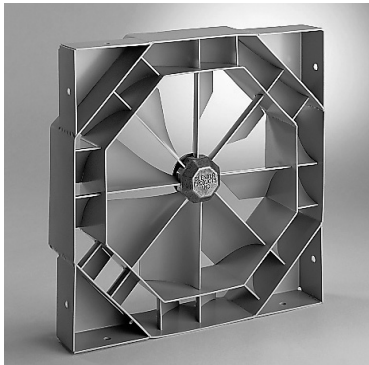

Figure 12: Internal Face and Bypass Dampers



Attenuators

Building occupants have become increasingly conscious of the quality of their environments, and low sound levels are a key criteria. Studies have confirmed improved productivity when workers are performing in sound-controlled environments. Consequently, building owners, engineers, and architects are designing their projects with stringent sound criteria to maximize this economic benefit.

Daikin Vision air handlers are designed to provide quiet sound levels. Factory-installed attenuators are available for the discharge or return sections of the air handling unit to meet the most stringent sound attenuation requirements. Different attenuator lengths can be selected to satisfy either the acoustic, space, pressure drop, or initial cost requirements. Quality construction and an aerodynamic design give reliable performance, low pressure drop and low initial cost. The Daikin SelectTools Software can help choose the correct attenuator for your application.

Figure 13: Attenuator Section



Digital Ready™ Air Handlers

Vision Air Handlers can be factory-equipped with industry standard direct digital control (DDC) components for easy, low cost integration with controls by others. Sensors and actuators are selected for maximum compatibility with most DDC control systems, and are neatly wired within their shipping section to a conveniently located junction box. Digital Ready Vision air handlers save the time and costly labor needed to identify, purchase and field install DDC components to match your control system. You also benefit from uniform, proper positioning of DDC components at our factory, which promotes reliable start-up and operation.

Starters and VFDs

A variety of factory-installed motor control options are available to provide operation and maintenance protection, motor efficiency, and flexibility for the Vision air handler.

These options include: Disconnect Switch, Starters, Combination Starter/Disconnect, Variable Frequency Drive (VFD) with Disconnect Switch, and VFD with Disconnect Switch and Bypass. Line reactors are available on both VFD with Disconnect Switch and VFD with Disconnect Switch and Bypass.

A unit mounted disconnect switch provides the means for disconnecting power in sight from the motor when required by the National Electric Code (NEC). The switch is a heavy-duty type with a non-fused disconnect switch in a NEMA 1 enclosure. A fused disconnect is also available.

Factory mounted starters offer remote start/stop operation and overload protection for an individual fan motor with minimum field cost to wire line and control circuit power to the unit. Two starter types are available, IEC or NEMA. IEC type starters are smaller in size and are a better value. Additional options include auxiliary contacts, control transformer, selector switch, push buttons, and pilot lights. A combination starter is a starter packaged with a safety switch. These motor controllers provide remote start/stop operation as well as disconnecting means in sight of the controller.

A VFD provides adjustable speed control of a single fan motor. Typically mounted outside the fan cabinet, the VFD provides not only a lower cost than field installation, but also an optimal installation location. VFDs are preprogrammed and include a keypad for local or remote control.

A unit installed VFD with disconnect provides local or remote speed control for a single fan motor with disconnecting means within sight when required by the NEC. A non-fused disconnect is offered packaged with the VFD in a separate NEMA 1 enclosure. Installation is limited to the connection of power and control wires at the device.

Packaged VFD with disconnect and bypass offers added motor control at the unit for critical fan applications. With bypass control, power to the VFD can be switched to allow full operation of the fan motor in case of VFD failure. VFDs with disconnect switch, bypass and line reactors provide harmonic control when needed.

Selecting Coils

The Vision air handler provides the ability to select from multiple face area coils per unit size. Once the coil size is selected, the row and fin requirements can be determined based on performance criteria. Daikin offers an extensive line of coil types and circuitings. This wide variety of circuiting, row, and fin spacing, in addition to different material types, can provide a coil selection that handles the load required.

Heating, cooling, and combination cooling and reheat sections are available. Coil sections come in many different depths to accommodate multiple rows of coils, and to provide access on the leaving air side or between coils for cleaning and inspection of the drain pan. Access in the coil section can be minimized or maximized depending on the space available and job needs. Coil sections can be placed as needed in the unit, and as many sections as required for conditioning of air can be provided.

Selecting Accessories

A complete selection of component and section types in a variety of unit arrangements and configurations is available for air mixing, filtration, and temperature control to meet specific application requirements. The outside and/or return air can be brought into the unit through a plenum, mixing box, or economizer. For mixing of the two air streams, dampers are required to modulate and direct outside and return air, which is accomplished using a mixing box or economizer. Both section types use the Daikin patented UltraSeal™ low leak dampers. Blenders/air mixers also are available to provide proper mixing of two air streams, to prevent stratification and to help avoid damage to equipment due to freezing temperatures.

To promote good air filtration, many different filter media types and arrangements are offered. Filters can be provided in flat filter racks, in a variety of media efficiencies, and with or without a prefilter. The filter section can be located anywhere in the unit to filter air as it enters the unit, or in a final filter arrangement before it leaves the unit. Bag or cartridge filters can be either front or side loading.

Also available are many different size access sections for field-installed components or to provide access between components. Other options include diffusers, plenums, face and bypass dampers, sound attenuators, and blenders/air mixers. Standard access doors open outward for maximum accessibility to internal components.

On pressurized sections, most doors open inward to help maintain the extremely low cabinet leakage rate of the Vision unit and to prevent doors from being inadvertently opened when the cabinet is under pressure.

Selecting Fans

WARNING

SMOKE CONTROL AND MANAGEMENT SYSTEMS

Improper smoke or fume air handling can result in severe personal injury or death. A registered professional engineer must design and approve the air conditioner and air handler application to make sure smoke and fume control meet local fire codes and NFPA requirements for the specific building application.

Fan selection requires an accurate calculation of the resistance to the airflow through the entire system. This total resistance consists of the sum of two parts—the external and internal static pressure. The external static pressure is the static pressure found in the distribution system, external to the air handler. The internal unit resistance is the sum of the resistance of the coils and various other unit components and accessories. Component pressure drops are listed for specific air flows in this catalog.

Use the Daikin SelectTools software to determine internal component pressure drops of the system. Once the total static pressure is known, the software identifies the fans available to properly handle the air flow and static pressure for the system. The software generates a full fan curve based on the fan selection and point of operation.

Table 4: Quick Select, Unit Sizes 107 to 169

Description	Unit size				
	107	124	141	160	169
Airflow range, cfm	29,000–77,500	33,600–89,500	40,300–107,400	45,600–121,800	48,400–129,000
cfm @ 500 ft/min through large face area coil	48,400	55,900	67,100	76,200	80,600
Height × width (in)	108 × 168	108 × 192	122 × 192	122 × 216	122 × 228
Cooling coil face area, sq ft					
Large	109.79	126.79	134.25	152.25	161.25
Medium	77.5	89.5	96.96	109.96	116.46
Fan section—depth (in)					
Largest housed fan and motor available with top horizontal discharge	92	92	92	92	92
Largest direct-drive plenum fan and motor available	78	78	78	78	78
Largest dual direct-drive plenum fan and motor available	78	78	78	78	78
Largest belt-drive plenum fan and motor available	68	68	68	68	68
Largest belt-drive dual plenum fan	50	54	54	56	60
Largest ECM fan available	30	30	30	30	30
Service gantry	30	30	30	30	30
Mixing box—depth (in)					
Mixing box only	64	64	72	72	72
Economizer—depth (in)					
Economizer	118	118	136	136	136
Blender—depth (in)					
Largest Kees	68	72	80	84	84
Largest Blender Products IV	78	86	92	92	92
Side load filter sections—depth (in)					
Flat 2" and 4"	22/24	22/24	22/24	22/24	22/24
Cartridge (12" deep with 2"/4" pre-filter)	22/24	22/24	22/24	22/24	22/24
Bag (36" with 2"/4" pre-filter)	44/46	44/46	44/46	44/46	44/46
Front load filter sections—depth (in)					
Cartridge (12" deep with 2"/4" pre-filter)	20/20	20/20	20/20	20/20	20/20
Bag (36" with 2"/4" pre-filter)	44/44	44/44	44/44	44/44	44/44
Face and bypass—depth (in)					
Internal	12	12	12	12	12
External	58	58	64	64	64
Coil sections—depth (in)					
Heating only (2-row water)	12	12	12	12	12
Cooling only (4-row water)	18	18	18	18	18
Cooling only (6-row water)	18	18	18	18	18
Cooling & reheat (12-row cooling & 1-row heating)	24	24	24	24	24
Access sections—depth (in)					
16" deep	16	16	16	16	16
24" deep	24	24	24	24	24
30" deep	30	30	30	30	30
36" deep	36	36	36	36	36
42" deep	42	42	42	42	42
48" deep	48	48	48	48	48
54" deep	54	54	54	54	54
Diffuse—depth (in)					
With housed fan	42	46	46	46	46
Attenuator—depth (in)					
Short	40	40	40	40	40
Medium	52	52	52	52	52
Long	64	64	64	64	64
Supply or return plenum—depth (in)					
Top or end opening	36	52	60	60	60

Note: Vision air handler units are available in 2-inch increments of height and 4-inch increments of width to fit the exact space requirements.

Installation Flexibility

Daikin central station Vision air handlers feature sectionalized design and can ship fully assembled or in sections as required by the job site condition to provide maximum installation flexibility. Multiple fan, coil, filter, mixing box, face and bypass, and access components allow the design flexibility of built-up systems with the cost advantage of factory fabricated units.

Mounting and Access

Take care to keep the supporting structure level and rigid enough for satisfactory unit operation. Ideally, a heavy concrete slab should be used for floor mounted units.

Locate units so there is proper access for routine service. Clearance for filter removal on both sides of the filter section is usually necessary. Provide clearance as required for access panels. Allow room for coil removal. Cooling units require clearance for a trap in the drain pan line.

Access to the interior of the Vision air handler is provided by hinged access doors or removable panels. For access between components, versatile access sections feature hinged access doors on either or both sides.

Ductwork

A well-designed duct layout minimizes system resistance and sound generation. Duct connections to and from units should allow straight, smooth airflow. Avoid discharge plenums or any abrupt change in duct size. Also avoid sharp turns in the fan discharge, particularly turns opposed to wheel rotation. If sharp bends are necessary, use turning vanes. See Figure 14 for good fan outlet practices.

Figure 14: Discharge Duct Layout

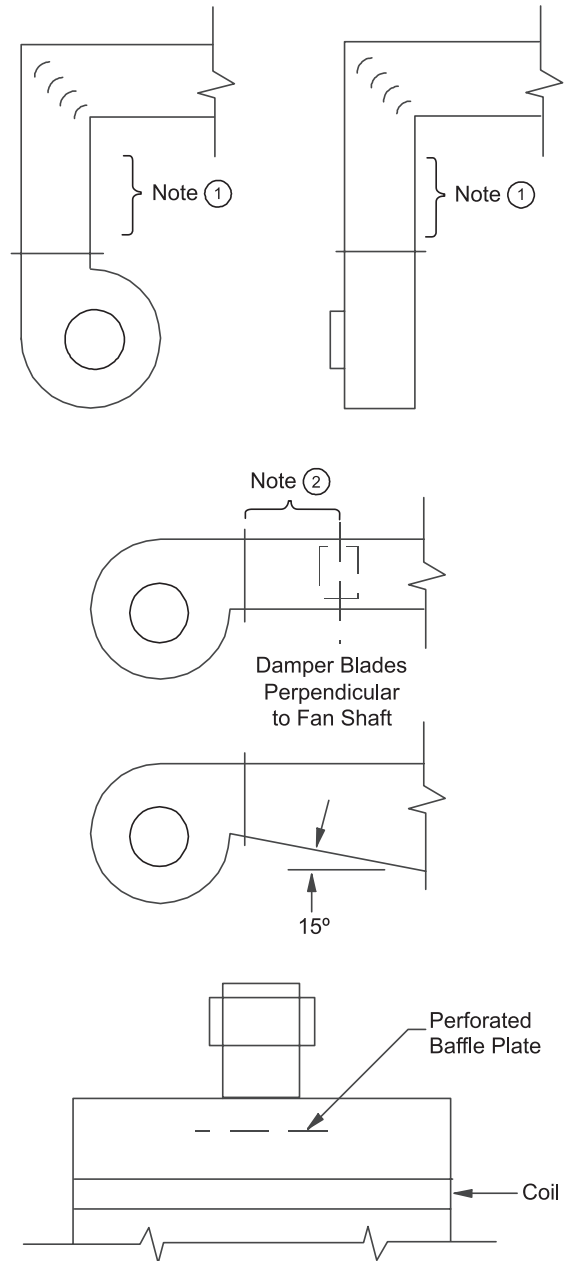

NOTE: Elbows should not be closer than 1-1/2 to 2-1/2 times the largest dimension of fan discharge opening. Place dampers at least 3 fan diameters downstream of the fan discharge.

Figures reprinted with permission from the 1979 ASHRAE Guide and - Data Book (Equipment).

Piping and Drain Pan Traps

Design and install piping in accordance with accepted industry standards. Do not apply undue stress at the connection to coil headers. Support pipe work independently of the coils with adequate piping flexibility for thermal expansion. Run drain lines and traps full size from the drain pan connection. Drain pans must have traps to allow the condensate from the coils to drain freely. On a draw-through unit, the trap depth and the distance between the trap outlet and drain pan outlet should be twice the negative static pressure under normal unit operation. See Figure 15.

Figure 15: Drain Pan Traps

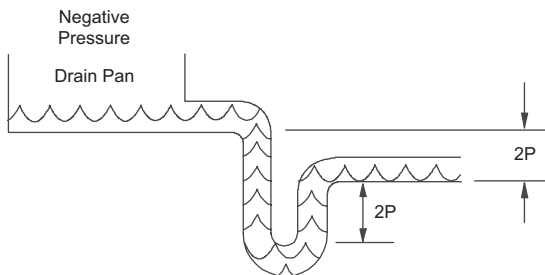

Vibration Isolation

To help keep noise and vibration compatible with the intended use of the conditioned air space, apply good acoustical and vibration engineering practices during the early stages of design.

Since most applications require vibration isolation, the Vision air handler is available with factory-installed internal isolation. Internally isolated units feature spring isolators sized specifically for each fan wheel and unit size.

Sound

The unit inlet, outlet, and radiated sound levels for each octave band are calculated by the Daikin SelectTools software, based on your specific application. Sound performance data is derived from testing performed in accordance with AMCA Standard 300. The effects of various components, casework, and unit configurations are taken into account.

Air Supply Systems and Fan Laws

An air supply system consists of an air handler cabinet, heat exchanger, filters, ductwork, grilles and registers used to distribute air throughout the building. The system is independent of the fan used to supply the system.

The resistance of the system, referred to as static pressure (SP), is dependent upon the quantity of air (cfm) that is moved through it. The air quantity is determined by the cooling, heating, and ventilating requirements.

For any system, the static pressure varies directly as the square of the air quantity. This relationship between cfm and SP establishes the system curve for that system and is expressed as follows:

$$\left(\frac{cfm_1}{cfm_2}\right)^2 = \frac{SP_1}{SP_2} \text{ or } SP_2 = SP_1 \left(\frac{cfm_2}{cfm_1}\right)^2$$

The system curve is unique for a particular system configuration. Any change to the system caused by dirty filters, damper changes, etc., results in a new system curve.

For fans operating at low pressures (less than 10" W.G.), the effects of air compression are negligible. Disregarding air compression allows fan operation in a fixed system to be expressed by simple relationships. These relationships are known as fan laws and can be used to calculate the effects of fan speed and air density changes on this system.

1 The flow rate varies directly with the change in fan speed:

$$\frac{cfm_1}{cfm_2} = \frac{rpm_1}{rpm_2} \text{ or } cfm_2 = cfm_1 \left(\frac{rpm_2}{rpm_1}\right)$$

A 10% increase in fan speed increases air quantity 10%.

2 The static pressure varies as the square of the change in fan speed:

$$\frac{SP_1}{SP_2} = \left(\frac{rpm_1}{rpm_2}\right)^2 \text{ or } SP_2 = SP_1 \left(\frac{rpm_2}{rpm_1}\right)^2$$

A 10% increase in fan speed increases static pressure 21%.

3 The fan brake horsepower varies as the cube of the change in fan speed:

$$\frac{HP_1}{HP_2} = \left(\frac{rpm_1}{rpm_2}\right)^3 \text{ or } HP_2 = HP_1 \left(\frac{rpm_2}{rpm_1}\right)^3$$

A 10% increase in fan speed increases horsepower 33%.

4 System static pressure and brake horsepower are directly proportional to the air density:

$$SP_2 = SP_1 \left(\frac{\text{density}_2}{\text{density}_1}\right) \left(\frac{rpm_2}{rpm_1}\right)^3$$

$$HP_2 = HP_1 \left(\frac{\text{density}_2}{\text{density}_1}\right) \left(\frac{rpm_2}{rpm_1}\right)^3$$

Consequently, the static pressure and brake horsepower decrease with an increase in air temperature or higher altitude, and increase with a decrease in air temperature or lower altitude.

To determine fan performance for temperatures and altitudes other than standard (70°F, 0 ft. altitude), the static pressure must be adjusted by the density ratio before the fan rpm and bhp requirements can be determined. Density ratios are expressed as temperature and altitude conversion factors in [Table 5](#).

Table 5: Temperature and Altitude Conversion Factors

Air temp. (°F)	Altitude (ft)								
	0	1000	2000	3000	4000	5000	6000	7000	8000
-20	1.20	1.16	1.12	1.08	1.04	1.00	0.97	0.93	0.89
0	1.15	1.10	1.08	1.02	0.99	0.95	0.92	0.88	0.85
20	1.11	1.06	1.02	0.98	0.95	0.92	0.88	0.85	0.82
40	1.06	1.02	0.98	0.94	0.91	0.88	0.84	0.81	0.78
60	1.02	0.98	0.94	0.91	0.88	0.85	0.81	0.79	0.76
70	1.00	0.96	0.93	0.89	0.86	0.83	0.80	0.77	0.74
80	0.98	0.94	0.91	0.88	0.84	0.81	0.78	0.75	0.72
100	0.94	0.91	0.88	0.84	0.81	0.78	0.75	0.72	0.70
120	0.92	0.88	0.85	0.81	0.78	0.76	0.72	0.70	0.67
140	0.89	0.85	0.82	0.79	0.76	0.73	0.70	0.68	0.65
160	0.85	0.82	0.79	0.76	0.74	0.70	0.68	0.65	0.63
200	0.80	0.77	0.75	0.72	0.69	0.67	0.64	0.62	0.60
250	0.75	0.72	0.69	0.67	0.65	0.62	0.60	0.58	0.56

Fan and Motor Heat

Motor and drive heat—The total energy input to any fan motor is consumed in two ways: by heat dissipated through the motor frame and by work output. The amount of heat dissipated by the motor is a function of its operating efficiency:

$$\text{Motor heat} = \text{input} \times (1 - \text{motor efficiency})$$

A small amount of the motor work output is dissipated by the drive mechanism, which also results in a heat gain. Belt drive losses are a function of belt tension and number of belts as well as power transmitted. Typical belt drive losses range from 2% to 6% of bhp.

Whether motor and drive heat gain become part of an air handling system cooling load depends on the motor location relative to the conditioned space. For air handlers with internal motors, the motor and drive are within the conditioned space. Therefore, the motor and drive add heat to the system. Subtract this heat from the cooling capacity and add it to the heating capacity of the unit.

Fan heat generation—All of the power input to a fan results in heat gain, which must be considered as a cooling load. The amount of heat generated is directly proportional to the fan bhp:

$$\text{Fan heat (Btuh)} = \text{bhp} \times 2545$$

Much of this heat generation occurs within the fan itself. Fans are not 100% efficient, and the energy losses that occur convert directly into heat. The work done by the fan on the airstream increases the temperature, pressure, and velocity of air. The heat of compression required to raise the airstream to this increased energy level is also a heat gain.

As the air travels throughout the building, its energy is deteriorated by friction, resulting in pressure drop. This is also heat gain, but it does not result in temperature rise because the air expands as the pressure is reduced. The expansion is a cooling process that offsets the heat generated by friction.

Typical fan and motor heat values are given in [Figure 16](#).

Figure 16: Fan and Motor Heat Gain Variable Air Volume

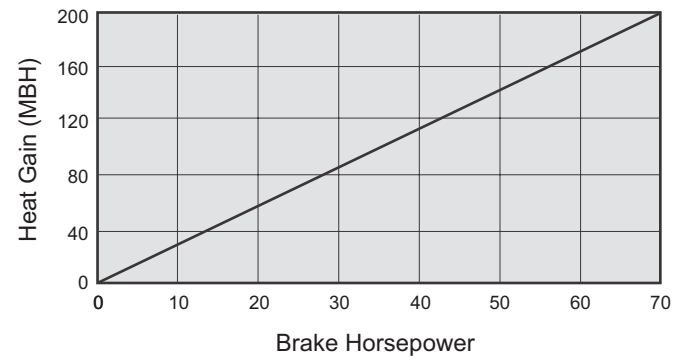

Daikin variable air volume systems (VAV) employ the concept of varying the air quantity to a space at a constant temperature thereby balancing the heat gains or losses and maintaining the desired room temperature. This true variable volume system is commonly referred to as a “squeeze-off” or “pinch-off” system. Unlike a “bypass” or “dump” system, supply air is diverted from areas where it is not required to areas that need cooling and, at system part load conditions, reduces the total fan volume. This ability to reduce supply air quantities not only provides substantial fan energy savings at partial load conditions, but it also minimizes equipment sizing.

Variable volume systems offer the following advantages:

- Lowers system first cost by using system diversity to reduce equipment and duct sizes.
- Lowers operating costs by reducing fan energy demands, especially at part load conditions.
- Lowers first cost by reducing space requirements for duct trunks and mechanical equipment.
- Provides system flexibility to match changing occupancy demands.

Variable Frequency Drives

Variable frequency drives offer reliable operation over a wide range of airflow, with advantages in sound and energy performance.

Variable frequency drives provide the most efficient means of variable volume control by taking advantage of the fan law relation between fan speed (rpm) and fan brake horsepower (bhp). Also, since airflow is reduced by changing fan speed, the noise penalties often associated with mechanical control devices, e.g. inlet vanes, are not introduced. The following equation illustrates how fan bhp varies as the cube of the change in fan speed:

$$HP_2 = HP_1 \left(\frac{\text{density}_2}{\text{density}_1} \right) \left(\frac{\text{rpm}_2}{\text{rpm}_1} \right)^3$$

In an ideal system, at 50% fan speed, brake horsepower would be reduced to 12.5% of that at full speed.

Variable frequency control varies the speed of the fan by adjusting the frequency and voltage to the motor. Keeping a constant volts/frequency ratio (constant magnetic flux) to the motor allows the motor to run at its peak efficiency over a wide range of speeds and resulting fan airflow volumes. Figure 17 illustrates on a fan curve the effect of varying air volume with a variable frequency drive.

Figure 17: Variable Frequency Drive Control

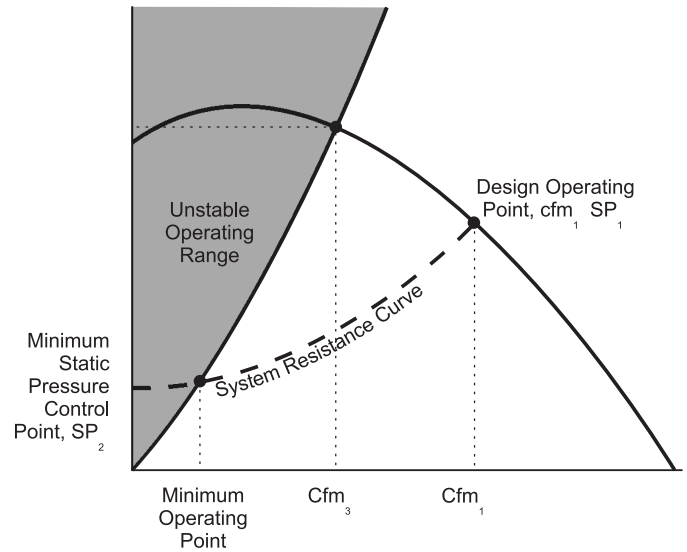

Table 6: Component Pressure Drops (Inches of Water)

Unit Size	CFM	Dampers		Face & BP face		Face & BP by-pass		Plenum		Diffuser	Blender**			Attenuator		
		MXB	Econ.	Int. med.	External Large	Int. med.	External Large	Top inlet	Top outlet		One	Two	Three	3 ft.	4 ft.	5 ft.
107	29100	0.08	0.08	0.02	0.02	0.21	0.11	0.06	0.01	0.15	0.03	0.17	—	0.02	0.02	0.02
	38750	0.08	0.08	0.03	0.02	0.38	0.11	0.05	0.01	0.15	0.05	0.30	—	0.03	0.04	0.05
	48400	0.08	0.08	0.05	0.03	0.59	0.17	0.06	0.02	0.15	0.08	0.47	—	0.05	0.07	0.08
	58100	0.08	0.08	0.07	0.05	0.85	0.24	0.06	0.03	0.15	0.11	—	—	0.07	0.10	0.11
124	33600	0.07	0.07	0.02	0.01	0.21	0.06	0.06	0.01	0.15	0.02	0.09	0.33	0.02	0.02	0.03
	44800	0.07	0.07	0.04	0.02	0.43	0.12	0.06	0.02	0.15	0.04	0.18	—	0.03	0.05	0.06
	55900	0.07	0.07	0.05	0.03	0.57	0.16	0.06	0.02	0.15	0.05	0.25	—	0.04	0.07	0.08
	67100	0.08	0.08	0.07	0.04	0.82	0.23	0.06	0.03	0.15	0.07	0.35	—	0.06	0.10	0.12
141	40300	0.07	0.07	0.02	0.01	0.16	0.06	0.06	0.01	0.15	0.03	0.14	—	0.02	0.03	0.03
	53650	0.07	0.07	0.04	0.02	0.29	0.11	0.06	0.02	0.15	0.05	0.24	—	0.03	0.05	0.05
	67100	0.08	0.08	0.06	0.03	0.45	0.17	0.06	0.02	0.15	0.08	0.38	—	0.05	0.08	0.09
160	80600	0.08	0.08	0.09	0.05	0.64	0.24	0.06	0.03	0.15	0.11	—	—	0.07	0.11	0.13
	45600	0.08	0.08	0.02	0.01	0.16	0.06	0.06	0.01	0.15	0.04	0.12	0.35	0.02	0.03	0.03
	60900	0.08	0.08	0.04	0.02	0.28	0.10	0.06	0.02	0.15	0.07	0.21	—	0.03	0.05	0.05
	76100	0.08	0.08	0.06	0.03	0.43	0.16	0.06	0.02	0.15	0.11	0.33	—	0.05	0.08	0.09
169	91400	0.08	0.08	0.09	0.05	0.62	0.24	0.06	0.04	0.15	0.16	0.48	—	0.07	0.12	0.13
	48400	0.08	0.08	0.02	0.01	0.18	0.06	0.06	0.01	0.15	0.05	0.09	0.29	0.02	0.03	0.03
	64500	0.08	0.08	0.04	0.02	0.31	0.10	0.06	0.02	0.15	0.08	0.16	—	0.03	0.05	0.05
	80600	0.08	0.08	0.06	0.03	0.49	0.16	0.06	0.02	0.15	0.13	0.25	—	0.05	0.08	0.09
169	96700	0.07	0.07	0.08	0.04	0.71	0.23	0.06	0.04	0.15	0.18	0.36	—	0.07	0.11	0.13

* Velocity exceeds 1000 fpm.

** Blender data based on Blender Products IV.

Table 7: Filter Media Face Areas and Velocity Through Media

Unit Size	CFM	Filter face areas (sq. ft.) and velocities (fpm)															
		2" throwaway (TA)				4" throwaway (TA)				12" or 4" cartridge				Bag Filter			
		Side Removal		Front Removal		Side Removal		Front Removal		Side Removal		Front Removal		Side Removal		Front Removal	
Area	Vel	Area	Vel	Area	Vel	Area	Vel	Area	Vel	Area	Vel	Area	Vel	Area	Vel		
107	29100	108.1	269	95	307	108.1	275	95	320	109.7	265	94.4	308	109.7	265	94.4	308
	38750	108.1	359	95	408	108.1	366	95	426	109.7	353	94.4	411	109.7	353	94.4	411
	48400	108.1	448	95	510	108.1	457	95	531	109.7	441	94.4	513	109.7	441	94.4	513
	58100	108.1	538	95	612	108.1	549	95	638	109.7	530	94.4	616	109.7	530	94.4	616
124	33600	126.2	266	110.4	304	121.4	277	105.8	317	125.8	267	109.6	306	125.8	267	109.6	306
	44800	126.2	355	110.4	406	121.4	369	105.8	423	125.8	356	109.6	409	125.8	356	109.6	409
	55900	126.2	443	110.4	506	121.4	460	105.8	528	125.8	444	109.6	510	125.8	444	109.6	510
	67100	126.2	532	110.4	608	121.4	553	105.8	634	125.8	533	109.6	612	125.8	533	109.6	612
141	40300	147.0	274	128.6	314	144.1	280	121.4	332	146.6	275	121.4	332	146.6	275	121.4	332
	53650	147.0	365	128.6	417	144.1	372	121.4	442	146.6	366	121.4	442	146.6	366	121.4	442
	67100	147.0	457	128.6	522	144.1	466	121.4	552	146.6	458	121.4	552	146.6	458	121.4	552
	80600	147.0	548	128.6	627	144.1	559	121.4	663	146.6	550	121.4	663	146.6	550	121.4	663
160	45600	165.8	275	147.4	309	159.3	286	121.4	375	164.9	276	146.6	311	164.9	276	146.6	311
	60900	165.8	367	147.4	413	159.3	382	121.4	501	164.9	369	146.6	415	164.9	369	146.6	415
	76100	165.8	459	147.4	516	159.3	478	121.4	626	164.9	461	146.6	519	164.9	461	146.6	519
	91400	165.8	551	147.4	620	159.3	574	121.4	752	164.9	554	146.6	623	164.9	554	146.6	623
169	48400	174.8	277	152.8	317	167.1	290	151.8	319	172.3	281	151.8	319	172.3	281	151.8	319
	64500	174.8	369	152.8	422	167.1	386	151.8	425	172.3	374	151.8	425	172.3	374	151.8	425
	80600	174.8	461	152.8	527	167.1	482	151.8	531	172.3	468	151.8	531	172.3	468	151.8	531
	96700	174.8	553	152.8	633	167.1	579	151.8	637	172.3	561	151.8	637	172.3	561	151.8	637

Table 8: Filter Media Air Pressure Drop Based on Clean Filters - High Efficiency Cartridge

Unit Size	CFM	Cartridge Filter											
		Varicel SH						Varicel II MH					
		12" - Side Removal			12" - Front Removal			4" - Side Removal			4" - Front Removal		
		MERV 11	MERV 13	MERV 14	MERV 11	MERV 13	MERV 14	MERV 11	MERV 14	MERV 15	MERV 11	MERV 14	MERV 15
107	29100	0.16	0.22	0.23	0.20	0.28	0.28	0.16	0.28	0.33	0.20	0.34	0.40
	38750	0.24	0.34	0.35	0.29	0.42	0.43	0.25	0.40	0.47	0.32	0.48	0.56
	48400	0.33	0.47	0.48	0.40	0.58	0.60	0.35	0.52	0.60	0.45	0.63	0.72
	58100	0.42	0.61	0.63	0.53	0.76	0.79	0.47	0.65	0.75	0.59	0.78	0.89
124	33600	0.16	0.22	0.23	0.20	0.28	0.28	0.16	0.28	0.33	0.20	0.34	0.40
	44800	0.24	0.34	0.35	0.29	0.42	0.43	0.25	0.40	0.47	0.32	0.48	0.56
	55900	0.33	0.47	0.48	0.40	0.58	0.60	0.35	0.52	0.60	0.45	0.63	0.72
	67100	0.42	0.61	0.63	0.53	0.76	0.79	0.47	0.65	0.75	0.59	0.78	0.89
141	40300	0.17	0.23	0.24	0.22	0.31	0.31	0.17	0.30	0.35	0.21	0.35	0.41
	53650	0.25	0.35	0.36	0.33	0.47	0.48	0.27	0.42	0.49	0.33	0.49	0.57
	67100	0.34	0.49	0.51	0.45	0.65	0.67	0.38	0.55	0.63	0.46	0.65	0.74
	80600	0.45	0.64	0.67	0.58	0.85	0.88	0.50	0.68	0.78	0.62	0.81	0.92
160	45600	0.17	0.23	0.24	0.20	0.28	0.29	0.17	0.30	0.35	0.21	0.34	0.40
	60900	0.25	0.36	0.37	0.30	0.43	0.44	0.27	0.42	0.49	0.32	0.49	0.56
	76100	0.35	0.50	0.51	0.41	0.59	0.61	0.38	0.55	0.64	0.46	0.64	0.73
	91400	0.45	0.65	0.68	0.53	0.77	0.81	0.50	0.69	0.79	0.61	0.80	0.91
169	48400	0.17	0.24	0.25	0.20	0.29	0.30	0.17	0.30	0.35	0.21	0.35	0.41
	64500	0.26	0.37	0.38	0.31	0.44	0.45	0.27	0.43	0.49	0.33	0.50	0.58
	80600	0.35	0.51	0.53	0.42	0.61	0.63	0.38	0.56	0.64	0.47	0.66	0.75
	96700	0.46	0.66	0.69	0.55	0.80	0.83	0.51	0.69	0.79	0.63	0.82	0.93

Table 9: Filter Media Air Pressure Drop Based on Clean Filters - Flat Panel

Unit Size	CFM	Flat Panel Filter							
		5700		PerfectPleatUltra		PerfectPleatHC		PerfectPleatUltra	
		2" - Side Removal	2" - Front Removal	2" - Side Removal	2" - Front Removal	4" - Side Removal	4" - Front Removal	4" - Side Removal	4" - Front Removal
		MERV 7		MERV 8		MERV 7		MERV 8	
107	29100	0.10	0.12	0.18	0.21	0.07	0.10	0.12	0.16
	38750	0.15	0.19	0.26	0.31	0.13	0.17	0.21	0.29
	48400	0.21	0.26	0.35	0.41	0.19	0.25	0.34	0.45
	58100	0.28	0.33	0.44	0.52	0.27	0.35	0.48	0.65
124	33600	0.10	0.12	0.18	0.21	0.07	0.10	0.12	0.16
	44800	0.15	0.19	0.26	0.31	0.13	0.17	0.21	0.29
	55900	0.21	0.26	0.35	0.41	0.19	0.25	0.34	0.45
	67100	0.28	0.33	0.44	0.52	0.27	0.35	0.48	0.65
141	40300	0.11	0.13	0.19	0.22	0.08	0.10	0.13	0.17
	53650	0.16	0.19	0.27	0.32	0.13	0.18	0.23	0.30
	67100	0.22	0.27	0.36	0.42	0.20	0.27	0.36	0.47
	80600	0.29	0.35	0.45	0.53	0.28	0.38	0.52	0.68
160	45600	0.11	0.13	0.19	0.22	0.08	0.13	0.13	0.17
	60900	0.16	0.19	0.27	0.32	0.14	0.23	0.23	0.30
	76100	0.22	0.26	0.36	0.42	0.21	0.34	0.37	0.46
	91400	0.29	0.34	0.45	0.53	0.29	0.48	0.53	0.67
169	48400	0.11	0.13	0.19	0.22	0.08	0.13	0.13	0.17
	64500	0.16	0.20	0.27	0.32	0.14	0.17	0.24	0.31
	80600	0.22	0.27	0.36	0.43	0.21	0.25	0.37	0.48
	96700	0.29	0.35	0.46	0.54	0.29	0.35	0.53	0.70

Table 10: Filter Media Air Pressure Drop Base on Clean Filters - High Efficiency Bag

Unit Size	CFM	High Efficiency Bag											
		DriPak 2000											
		12" Side Removal	12" Front Removal	15" Side Removal	15" Front Removal	19" Side Removal	19" Front Removal	21" Side Removal	21" Front Removal	21" Side Removal	21" Front Removal	21" Side Removal	21" Front Removal
		MERV 8						MERV 11		MERV 14		MERV 15	
107	29100	0.12	0.14	0.09	0.11	0.07	0.09	0.17	0.19	0.25	0.30	0.38	0.44
	38750	0.16	0.18	0.13	0.16	0.11	0.14	0.22	0.25	0.34	0.39	0.50	0.58
	48400	0.20	0.23	0.17	0.21	0.15	0.19	0.27	0.31	0.42	0.49	0.62	0.72
	58100	0.23	0.27	0.22	0.26	0.20	0.25	0.32	0.36	0.51	0.59	0.74	0.86
124	33600	0.13	0.14	0.09	0.11	0.07	0.09	0.17	0.19	0.26	0.29	0.38	0.44
	44800	0.16	0.18	0.13	0.16	0.11	0.14	0.22	0.25	0.34	0.39	0.50	0.58
	55900	0.20	0.22	0.17	0.20	0.16	0.19	0.27	0.31	0.43	0.49	0.62	0.71
	67100	0.23	0.26	0.22	0.26	0.20	0.25	0.32	0.36	0.51	0.59	0.75	0.85
141	40300	0.13	0.15	0.09	0.11	0.08	0.09	0.17	0.20	0.26	0.30	0.39	0.45
	53650	0.17	0.19	0.13	0.16	0.12	0.14	0.23	0.26	0.35	0.40	0.52	0.59
	67100	0.20	0.23	0.18	0.21	0.16	0.20	0.28	0.31	0.44	0.50	0.64	0.73
	80600	0.24	0.27	0.23	0.27	0.21	0.26	0.33	0.37	0.53	0.61	0.77	0.88
160	45600	0.13	0.14	0.09	0.11	0.08	0.09	0.17	0.19	0.27	0.30	0.39	0.44
	60900	0.17	0.19	0.14	0.16	0.12	0.14	0.23	0.25	0.35	0.40	0.52	0.58
	76100	0.20	0.23	0.18	0.21	0.16	0.20	0.28	0.31	0.44	0.50	0.64	0.73
	91400	0.24	0.27	0.23	0.27	0.21	0.26	0.33	0.37	0.53	0.61	0.77	0.88
169	48400	0.13	0.14	0.09	0.11	0.08	0.09	0.17	0.19	0.27	0.30	0.39	0.44
	64500	0.17	0.19	0.14	0.16	0.12	0.14	0.23	0.25	0.35	0.40	0.52	0.58
	80600	0.20	0.23	0.18	0.21	0.16	0.20	0.28	0.31	0.44	0.50	0.64	0.73
	96700	0.24	0.27	0.23	0.27	0.21	0.26	0.33	0.37	0.53	0.61	0.77	0.88

Table 11: Filter Media Air Pressure Drop Base on Clean Filters - High Efficiency Bag (Continued)

Unit Size	CFM	High Efficiency Bag											
		DriPak 2000											
		30" Side Removal	30" Front Removal	30" Side Removal	30" Front Removal	30" Side Removal	30" Front Removal	36" Side Removal	36" Front Removal	36" Side Removal	36" Front Removal	36" Side Removal	36" Front Removal
		MERV 11		MERV 14		MERV 15		MERV 11		MERV 14		MERV 15	
107	29100	0.15	0.17	0.19	0.22	0.27	0.31	0.11	0.13	0.16	0.18	0.22	0.26
	38750	0.19	0.22	0.25	0.30	0.35	0.41	0.15	0.17	0.21	0.24	0.30	0.35
	48400	0.23	0.27	0.32	0.37	0.44	0.51	0.19	0.22	0.26	0.30	0.38	0.44
	58100	0.27	0.31	0.38	0.44	0.53	0.61	0.22	0.26	0.31	0.35	0.46	0.53
124	33600	0.15	0.17	0.19	0.22	0.27	0.31	0.12	0.13	0.16	0.18	0.23	0.26
	44800	0.19	0.22	0.26	0.29	0.36	0.41	0.15	0.17	0.21	0.24	0.30	0.35
	55900	0.23	0.26	0.32	0.37	0.44	0.51	0.19	0.26	0.30	0.44	0.38	0.44
	67100	0.28	0.31	0.38	0.44	0.53	0.61	0.22	0.25	0.31	0.35	0.46	0.53
141	40300	0.15	0.17	0.20	0.23	0.28	0.32	0.12	0.13	0.16	0.19	0.23	0.27
	53650	0.20	0.22	0.26	0.30	0.37	0.42	0.16	0.18	0.21	0.24	0.31	0.36
	67100	0.24	0.27	0.33	0.38	0.46	0.52	0.19	0.22	0.27	0.30	0.39	0.45
	80600	0.28	0.32	0.40	0.45	0.55	0.63	0.23	0.26	0.32	0.36	0.47	0.55
160	45600	0.15	0.17	0.20	0.22	0.28	0.31	0.12	0.13	0.16	0.18	0.23	0.26
	60900	0.20	0.22	0.27	0.30	0.37	0.42	0.16	0.18	0.22	0.24	0.31	0.36
	76100	0.24	0.27	0.33	0.38	0.46	0.52	0.19	0.22	0.27	0.30	0.39	0.45
	91400	0.28	0.32	0.40	0.45	0.55	0.63	0.23	0.26	0.32	0.36	0.47	0.54
169	48400	0.15	0.17	0.20	0.22	0.28	0.31	0.12	0.13	0.16	0.18	0.23	0.26
	64500	0.20	0.22	0.27	0.30	0.37	0.42	0.16	0.18	0.22	0.24	0.31	0.36
	80600	0.24	0.27	0.33	0.38	0.46	0.52	0.19	0.22	0.27	0.30	0.39	0.45
	96700	0.28	0.32	0.40	0.45	0.55	0.63	0.23	0.26	0.32	0.36	0.47	0.55

Figure 18: Coil Air Pressure Drop—HI-F5 Fin Type (2 Through 12 Rows)

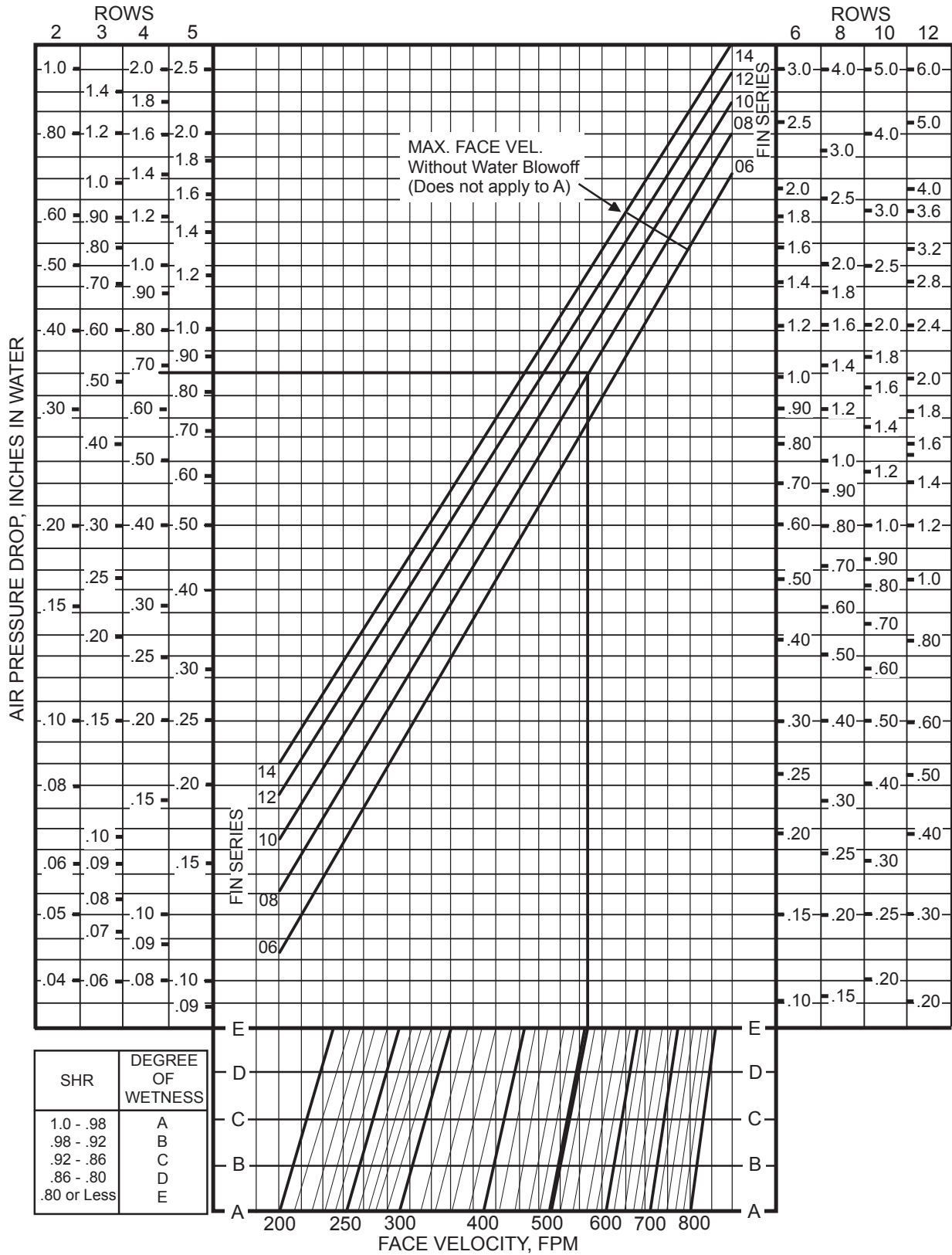

- Notes:
- The letters A,B,C,D or E following the face velocity indicate the degree of wetness at which the coil is operating.
 - Dry coils are shown by the letter A, wet coils by the letter E. Intermediate conditions are shown by the letters B, C, and D.
 - Air pressure drop for odd fin spacings can be found by interpolation.

Figure 19: Coil Air Pressure Drop—E-F5 Fin Type (2 Through 12 Rows)

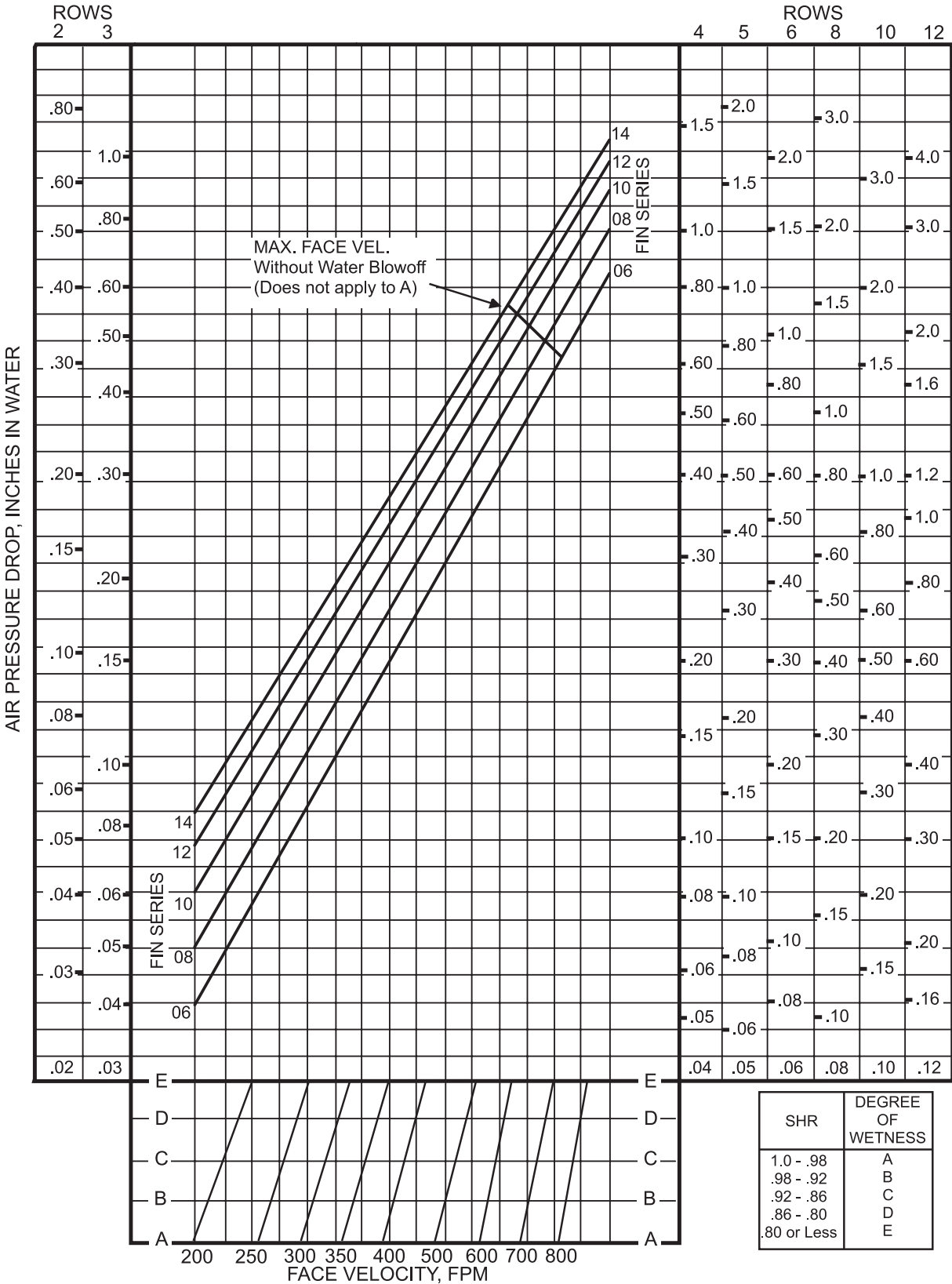

- Notes:
- The letters A,B,C,D or E following the face velocity indicate the degree of wetness at which the coil is operating.
 - Dry coils are shown by the letter A, wet coils by the letter E. Intermediate conditions are shown by the letters B, C, and D.
 - Air pressure drop for odd fin spacings can be found by interpolation.

Figure 20: Coil Air Pressure Drop—HI-F5 Fin Type

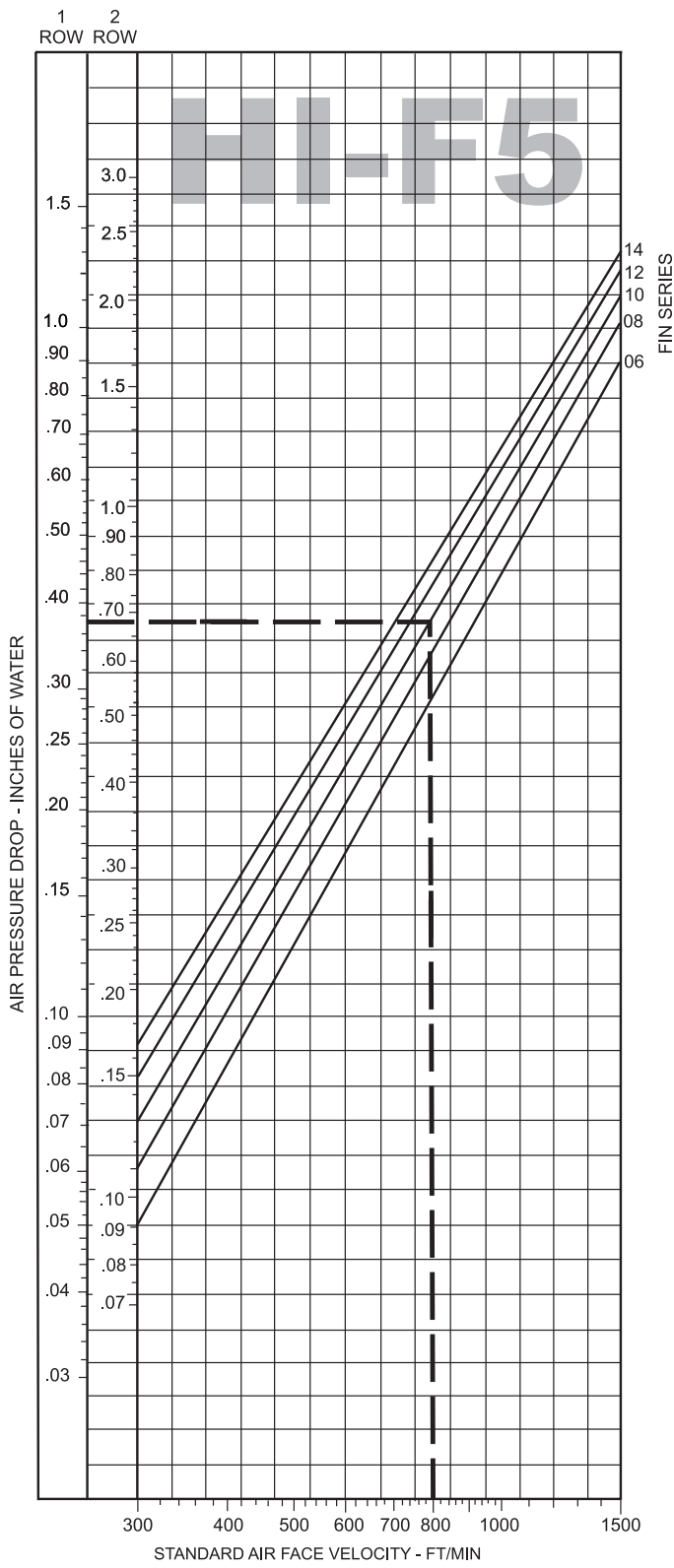
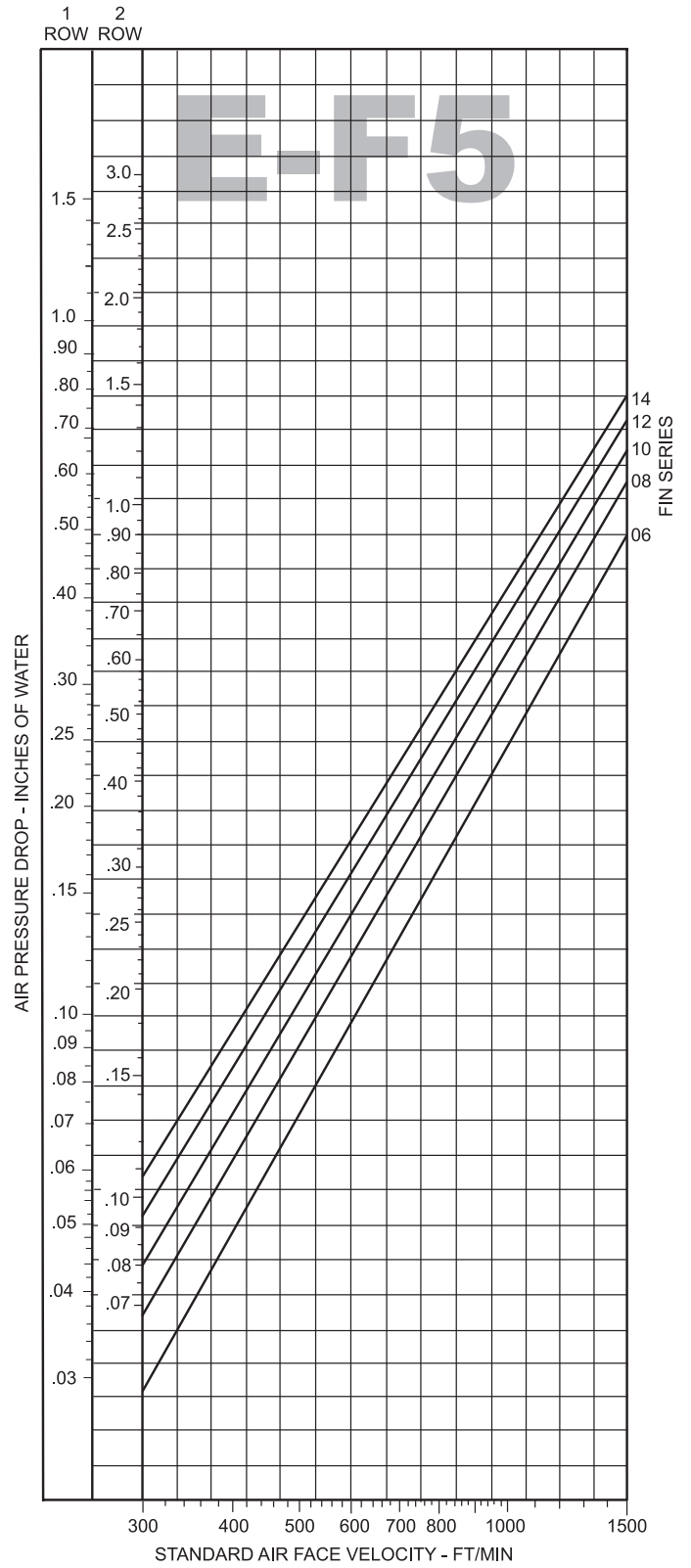
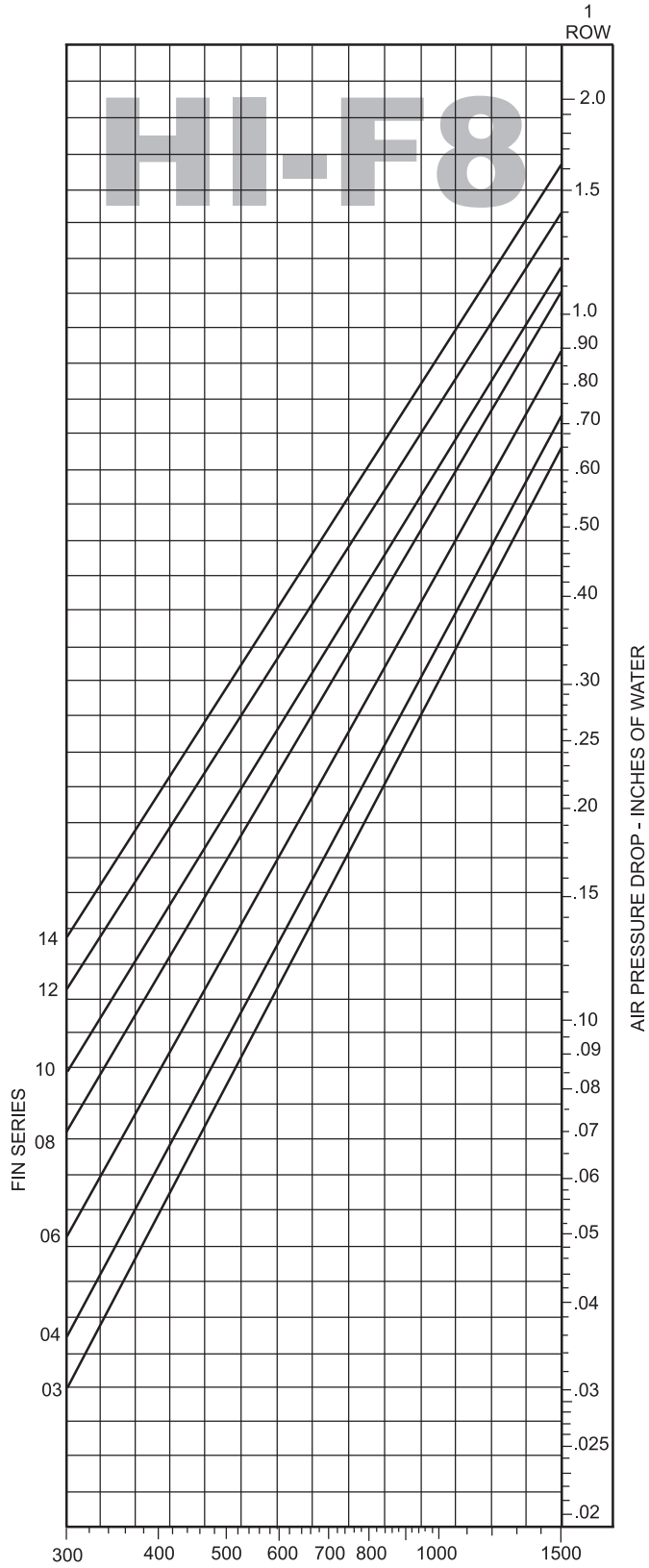

Figure 21: Coil Air Pressure Drop—E-F5 Fin Type



Note:
Air pressure drop for odd fin spacings can be found by interpolation.

Figure 22: 1" Steam Coil Air Pressure Drop



Note:
Air pressure drop for odd fin spacings can be found by interpolation.

Component and Section Weights

Table 12: Unit Coil Weights - lbs. (kg)

Unit Size	Rows								
	1	2	3	4	5	6	8	10	12
107	364 (165)	714 (324)	1173 (532)	1507 (684)	1842 (836)	2174 (986)	2894 (1313)	3112 (1412)	3325 (1508)
124	436 (198)	807 (366)	1378 (625)	1774 (805)	2225 (1009)	2622 (1189)	3304 (1499)	4071 (1847)	4840 (2195)
141	354 (161)	884 (401)	1614 (732)	2176 (987)	2612 (1185)	3082 (1398)	3909 (1773)	4822 (2187)	5735 (2601)
160	529 (240)	986 (447)	1798 (816)	2325 (1055)	2913 (1321)	3428 (1555)	4385 (1989)	5415 (2456)	6456 (2928)
169	406 (184)	1037 (470)	1891 (858)	2436 (1105)	2991 (1357)	3535 (1603)	4629 (2100)	5712 (2591)	6811 (3089)

Notes: 1 and 2-row coils based on heating coils with no side plates. All coils based on 8 fpi.

Table 13: Weights for Single Speed and Dual Speed Motors - lbs. (kg)

Motor rpm	Motor hp	1/4	1/3	1/3	3/4	1	1-1/2	2	3	5	7-1/2	10	15	20	25	30	40	50	60	75	100	125	150
900 rpm	NEMA frame	—	—	—	—	182T	184T	213T	215T	254T	256T	284T	286T	324T	326T	364T	365T	404T	405T	444T	—	—	—
	Motor Weight	—	—	—	—	56 (25)	64 (29)	94 (43)	111 (50)	150 (68)	207 (94)	300 (136)	300 (136)	385 (175)	415 (188)	580 (263)	580 (263)	750 (340)	800 (363)	1100 (499)	—	—	—
1200 rpm	NEMA frame	—	—	—	—	145T	182T	184T	213T	215T	254T	256T	284T	286T	324T	326T	364T	365T	404T	405T	—	—	—
	Motor Weight	—	—	—	—	44 (20)	66 (30)	85 (39)	114 (52)	145 (66)	224 (102)	248 (112)	330 (150)	377 (171)	450 (204)	487 (221)	703 (319)	720 (327)	1153 (523)	1200 (544)	—	—	—
1800 rpm	NEMA frame	48	48	56	56	143T	145T	145T	182T	184T	213T	215T	254T	256T	284T	286T	324T	326T	364T	365T	404T	405T	444T
	Motor Weight	19 (9)	24 (11)	35 (16)	35 (16)	44 (20)	54 (24)	54 (24)	84 (38)	100 (45)	139 (63)	165 (75)	242 (110)	273 (124)	351 (159)	432 (196)	531 (241)	592 (269)	714 (324)	895 (406)	1186 (538)	1663 (754)	1752 (795)
3600 rpm	NEMA frame	—	—	—	—	56	145T	145T	182T	184T	213T	215T	254T	256T	284TS	286TS	324TS	326TS	405TS	—	—	—	
	Motor Weight	—	—	—	—	32 (15)	40 (18)	40 (18)	50 (23)	76 (34)	91 (41)	110 (50)	147 (67)	182 (83)	223 (101)	359 (163)	369 (167)	447 (203)	558 (253)	713 (323)	—	—	—
1800/900 rpm	NEMA frame	—	—	—	—	143T	145T	145T	182T	184T	213T	215T	254T	256T	284T	286T	324T	326T	—	—	—	—	
	Motor Weight	—	—	—	—	25 (11)	28 (13)	31 (14)	63 (29)	72 (33)	104 (47)	130 (59)	244 (111)	232 (105)	250 (113)	275 (125)	350 (159)	390 (177)	—	—	—	—	
1800/1200 rpm	NEMA frame	—	—	—	—	145T	182T	182T	184T	215T	256T	256T	284T	286T	286T	—	—	—	—	—	—	—	
	Motor Weight	—	—	—	—	30 (14)	56 (25)	65 (29)	73 (33)	113 (51)	211 (96)	237 (108)	318 (144)	348 (158)	349 (158)	295 (134)	—	—	—	—	—	—	

* Data included reflects the largest NEMA frame and/or the heaviest motor weight per motor hp.

Table 14: 8" Base Rail Weights - lbs. (kg)

Unit Size	Fan section	24" Access section
107	730 (331)	521 (236)
124	746 (338)	556 (252)
141	760 (345)	567 (257)
160	776 (352)	607 (275)
169	783 (355)	627 (284)

Fan Data

Table 15: Physical Data—Forward Curved and Airfoil Fans, Unit Sizes 107 to 169 - in. (mm)

Forward curved										
Diameter Class I	20 (508)	22.38 (568)	25 (635)	27.62 (702)	30.25 (768)	33 (838)	36 (914)			
Maximum rpm	1010	930	790	690	650	600	560			
Shaft and bearing diameter	1.438 (37)	1.438 (37)	1.688 (43)	1.688 (43)	1.688 (43)	2.188 (56)	2.188 (56)			
Outlet area, sq.ft. (sq.m.)	4.2 (0.39)	5.1 (0.474)	6.71 (0.623)	8.07 (0.75)	9.3 (0.864)	12.05 (1.119)	12.8 (1.189)			
Diameter Class II	20 (508)	22.38 (568)	25 (635)	27.62 (702)	30.25 (768)	33 (838)	36 (914)			
Maximum rpm	1281	1178	1011	910	835	763	715			
Shaft and bearing diameter	1.688 (43)	2.188 (56)	2.438 (62)	2.438 (62)	2.688 (68)	2.688 (68)	2.688 (68)			
Outlet area, sq.ft. (sq.m.)	4.2 (0.39)	5.1 (0.474)	6.71 (0.623)	8.07 (0.75)	9.3 (0.864)	12.05 (1.119)	12.8 (1.189)			
Airfoil										
Diameter Class I	20 (508)	22.25 (565)	24.5 (622)	27 (686)	30 (762)	33 (838)	36.5 (927)	40.25 (1022)	44.5 (1130)	49.0 (1244)
Maximum rpm	2077	1875	1691	1479	1328	1209	1073	972	884	805
Shaft and bearing diameter	1.688 (43)	1.938 (49)	2.188 (56)	2.188 (56)	2.438 (62)	2.438 (62)	2.438 (62)	2.938 (75)	3.188 (81)	3.438 (87)
Outlet area, sq.ft. (sq.m.)	4.14 (0.385)	5.12 (0.476)	6.21 (0.577)	7.54 (0.7)	9.31 (0.865)	11.27 (1.047)	13.79 (1.281)	16.77 (1.558)	20.5 (1.905)	24.9 (2.313)
Diameter Class II	20 (508)	22.25 (565)	24.5 (622)	27 (686)	30 (762)	33 (838)	36.5 (927)	40.25 (1022)	44.5 (1130)	49.0 (1244)
Maximum rpm	2703	2413	2199	1928	1730	1579	1401	1264	1146	1040
Shaft and bearing diameter	2.188 (56)	2.188 (56)	2.438 (62)	2.438 (62)	2.688 (68)	2.938 (75)	2.938 (75)	3.438 (87)	3.938 (100)	3.938 (100)
Outlet area, sq.ft. (sq.m.)	4.14 (0.385)	5.12 (0.476)	6.21 (0.577)	7.54 (0.7)	9.31 (0.865)	11.27 (1.047)	13.79 (1.281)	16.77 (1.558)	20.5 (1.905)	24.9 (2.313)

Table 16: Physical Data—Belt -Drive Plenum Fans - in. (mm)

Fan Size	13	15	16	18	20	22	24	27	30	33	36	40	44	49	54	60
Diameter Class II	13.56 (344)	15.25 (387)	17.88 (454)	18.25 (464)	20.0 (508)	22.25 (565)	24.5 (622)	27.0 (686)	30.0 (762)	33.0 (838)	36.5 (927)	40.25 (1022)	44.5 (1130)	49.0 (1245)	54.25 (1378)	60.0 (1524)
Maximum rpm	3909	3468	2820	2930	2674	2403	2183	1860	1783	1620	1465	1329	1202	1091	986	891
Shaft and bearing diameter	1.1875 (30.2)	1.1875 (30.2)	1.1875 (30.2)	1.4375 (36.5)	1.4375 (36.5)	1.6875 (42.9)	1.6875 (42.9)	1.6875 (42.9)	1.9375 (49.2)	2.1875 (55.6)	2.1875 (55.6)	2.1875 (55.6)	2.1875 (61.9)	2.4375 (61.9)	2.4375 (61.9)	2.9375 (74.6)
Outlet area, sq.ft. (sq.m.)	N/A															

Table 17: Physical Data—Direct-Drive Plenum Fans - in. (mm)

Diameter Class II	11	12	15	16	18	20	22	24	27	30	33	36	40	44
	(279)	(305)	(381)	(406)	(457)	(508)	(559)	(610)	(686)	(762)	(838)	(914)	(1016)	(1118)
Maximum rpm	4000	4000	3909	3650	3650	2674	2403	2183	1981	1783	1620	1465	1329	1202

NOTE: Includes fan array

Coil Data

Table 18: Coil Dimensional Data - in. (mm), sq.ft. (sq.m.)

Unit Size	Coil Size				
		Medium		Large	
		Standard	Split	Standard	Split
107	Height	36 (914)	36 (914)	45 (1143)	48 (1219)
	Length	155 (3937)	71 (1803)	155 (3937)	71 (1803)
	Area	96.88 (9.0)	71 (6.60)	96.88 (9.0)	94.66 (8.79)
124	Height	36 (914)	36 (914)	45 (1143)	48 (1219)
	Length	179 (4547)	83 (2108)	179 (4547)	83 (2108)
	Area	89.5 (8.31)	83 (7.71)	111.88 (10.39)	110.66 (10.28)
141	Height	42 (1067)	42 (1067)	54 (1372)	54 (1372)
	Length	179 (4547)	83 (2108)	179 (4547)	83 (2108)
	Area	104.42 (9.7)	96.83 (9.0)	134.25 (12.47)	124.5 (11.57)
160	Height	42 (1067)	42 (1067)	54 (1372)	54 (1372)
	Length	203 (5156)	95 (2413)	203 (5156)	95 (2413)
	Area	118.42 (11.0)	110.83 (10.3)	152.25 (14.14)	142.5 (13.24)
169	Height	42 (1067)	42 (1067)	54 (1372)	54 (1372)
	Length	215 (5461)	101 (2565)	215 (5461)	101 (2565)
	Area	125.42 (11.65)	117.83 (10.95)	161.25 (14.98)	151.5 (14.07)

Note: Standard coils are a quantity of 2 coils stacked with an intermediate drain pan.
 Split coils are a quantity of 4 coils same as stacked with a center split.

Side Load Filter Data

Table 19: Filter Quantity Data

Unit Size	Filter Size	Throwaway		Bag Filter	
		2" or 4" (TA)		12" or 4" cartridge	
		Side	Front	Side	Front
107	12 × 24	0	0	0	0
	20 × 20	5	0	30	0
	20 × 24	0	0	0	0
	24 × 12	0	0	0	6
	24 × 20	30	30	10	12
	24 × 24	0	0	0	12
124	12 × 24	0	0	0	0
	20 × 20	30	30	0	30
	20 × 24	0	0	0	0
	24 × 12	0	0	8	0
	24 × 20	15	10	16	10
	24 × 24	0	0	16	0
141	12 × 24	0	0	0	0
	20 × 20	6	6	0	8
	20 × 24	24	24	0	32
	24 × 12	0	0	0	0
	24 × 20	3	2	8	0
	24 × 24	12	8	32	0
160	12 × 24	0	0	0	0
	20 × 20	0	0	0	0
	20 × 24	0	0	0	0
	24 × 12	0	0	0	0
	24 × 20	9	8	9	8
	24 × 24	36	32	36	32
169	12 × 24	0	0	4	0
	20 × 20	3	10	0	10
	20 × 24	12	40	0	40
	24 × 12	0	0	0	0
	24 × 20	7	0	9	0
	24x24	28	0	36	0

This section provides examples of output from our Daikin Tools Selection Software. Included are technical data sheets, unit drawings, fan curves, and summary fax sheet. This information is readily available based performance requirements from your project schedule.

Technical data sheets (below) include details of each section and component performance characteristics including airflow, air pressure drops, capacity, entering/leaving air temperatures, filtration, return/supply fan data, section/unit weights, and sound levels. Please contact our local Daikin sales office for a selection on your next project.

Figure 23: Sample Output from Daikin Selection Software

107 Extended Size Air Handling Unit

Technical Data Sheet

JOB NAME	U8G064(XX.000)		REP. OFFICE	House Account	
JOB DESCRIPTION	Extended Sizes		SALESPERSON	MO	
MODEL NUMBER	CAH107GDAC		ENGINEER		
UNIT TAGGING	107		VERSION	8.74	
Unit configuration					
Unit configuration	Inline horizontal				
Drive (hanging) location	Right				
SUPPLY			RETURN / EXHAUST		
Air volume	48400				scfm
Altitude	0				ft
Turning loss	0.0				ins WC.
External static	2.0				ins WC.
Total static	5.01				ins WC.
External H × W	108 × 168 (Not including base rails)				ins
CASING DETAILS					
Outer panel	Standard G90 galv steel (unpainted)				
Liner	Galvanized steel (Unless noted per section)				
Insulation	R-13 Injected Foam (Unless noted per section)				
Frame	2 ins				
Base	8" formed channel				
Sound baffles	None (unless noted per section)				
Tread Plate floor liner	None (unless noted per section)				
1 MIXING BOX(72 ins)					SECTION 1
Drip pan	None		Drip side		
OUTSIDE AIR			RETURN AIR		
Length × Width	68.00 × 80.00		68.00 × 80.00		ins
Location	End		Top		
Dampers	UltraSeal Low Leak		UltraSeal Low Leak		
Actuation	—		—		
Rated cfm	48400		48400		cfm
Air pressure drop	0.05				
DOOR DATA					
Door location	Drive side		Window size		None
Door width	28	ins	Light		None
Door opening	Outward				
2 BLENDER(52 ins)					SECTION 2
Model	Kees Inc.				
Qty	2				
Total face area	23.0				ft ²
Face velocity	1052				fpm
Air pressure drop	0.26				ins WC
Drip pan	None		Drip side		—

Figure 23 continued: Sample Output from Daikin Selection Software

3 COMBINATION FILTER(22 ins)						SECTION	2
Access	Side		Face velocity	441			fpm
Air volume	48400	cfm	Face area	109.7			ft ²
	PRE-FILTER		FILTER				
Type	Throwaway (MERV 7)		Varicel SH cartridge				
Efficiency	—		85				%
Clean air press. drop	0.21		0.47				ins WC
Mean air press. drop	0.6		0.83				ins WC
Dirty air press. drop	1.0		1.2				ins WC
Depth	2.0		12.0				ins
BANK ARRANGEMENT							
No. of Filters	Size H x W						
10	20.0 x 24.0 x 2.0	ins					
30	20.0 x 20.0 x 2.0	ins					
DOOR DATA							
Door location	Drive side		Window size	None			
Door width	18	ins	Light	None			
Door opening	Outward						
SPECIAL							
—							
Tread Plate floor liner	None						
Liner	(As casing details)						
Insulation	(As casing details)						
Sound baffles	None						
Special static pressure	—	ins WC	Filter Gauge	Minihelic II 0-3"			
4 HOT WATER COIL (12 ins)						SECTION	2
Coil model	5WS0702C		Number of coils	3			
Capacity	2654590	Btu/h	Number of rows	2			
			Fins per inch	7			
Air volume	48400	cfm					
Entering db	40.0	°F	Entering water	160.0			°F
Leaving db	90.2	°F	Leaving water	139.9			°F
Finned height x length	30 x 152	ins	Water flow rate	264.6			gpm
Face area	95.00	ft ²	Water pressure drop	8.7			ftHD
Face velocity	509	ft/m	Water velocity	4.7			ft/s
Coil air pressure drop	0.26	ins WC					
			Fluid volume	27.0			gal
			Fluid weight	228.0			lb
Connection type	Threaded		Fin material	Aluminum (0.0075)			
Connection Qty x size	2 x 2.50	ins	Tube material	Copper (0.02)			
Connection location	Drive side		Header material	Copper			
Connection material	Carbon steel		Case material	Galvanized track			
Glycol type (%)	-(0 %)		Drip pan	None			
Fouling Factor	0		Drip pan side	—			
			Turbospirals	None			
Coil code	5WS0702C		Electro-fin coat	None			
5 CHILLED WATER COIL(24 ins)						SECTION	3
Coil model	5WM1005C		Number of coils	2			
Total capacity	1937893	Btu/h	Number of rows	5			
Sensible capacity	1351492	Btu/h	Fins per inch	10			
Air volume	48400	cfm					
Entering db/wb	80.0 / 67.0	°F	Entering water	45.0			°F
Leaving db/wb	54.5 / 54.0	°F	Leaving water	55.0			°F
Finned height x length	45 x 155	ins	Water flow rate	387.6			gpm
Face area	96.88	ft ²	Water pressure drop	18.9			ftHD
Face velocity	500	ft/m	Water velocity	4.6			ft/s
Coil air pressure drop	1.00	ins WC					
			Fluid volume	62.0			gal
			Fluid weight	523.0			lb
Connection type	Threaded		Fin material	Aluminum (0.0075)			
Connection Qty x size	2 x 3.00	ins	Tube material	Copper (0.02)			
Connection location	Drive side		Header material	Copper			
Connection material	Carbon steel		Case material	Galv. steel			
Glycol type (%)	-(0 %)		Drain pan	Stainless steel			
Fouling Factor	0		Drain pan side	Drive side			
			Turbospirals	None			
Coil code	5WM1005C		Electro-fin coat	None			
DOOR DATA							
Door location	Drive side		Window size	None			
Door width	8	ins	Light	Marine light kit and switch only			
Door opening	Outward						

Figure 23 continued: Sample Output from Daikin Selection Software

6 SUPPLY FAN SECTION (94 ins)										SECTION	4	
Air volume	48400		cfm	Motor power	60.0						HP	
External static pressure	2.00		ins WC	Motor type	ODP							
Total static pressure	5.01		ins WC	Frame size	364 T frame							
				Electrical supply	460/60/3							
Type	—			Motor efficiency	Premium							
Blade type/Class	Airfoil / 2			Motor speed	1750						rpm	
Fan wheel diameter	44.50		ins	Motor pole	4							
Brake horsepower	51.81		HP	Full load current	70						A	
Operating/Max speed	892 / 1146		rpm	Lock rotor current	456						A	
Orientation	Top horizontal			Motor supplier	Generic							
Air modulation	None			Actual drive service fac.	1.34							
Drip pan	None			Bearing type	Standard -L50 (200K)							
Drip pan side	—			Outlet velocity	2333						ft/m	
Wheel guard	None			Inlet screen	None							
Belt guard	None			Outlet screen	None							
Inspection port	None											
DRIVES												
Fan sheave	4TB184			Motor sheave	4B5V90							
Number of belts	4			Belt	BX116							
ANTI-VIBRATION MOUNTS / SPRINGS												
Type	Spring											
Seismic restraint	None											
DOOR DATA												
Door location	Drive side			Window size	None							
Door width	30		ins	Light	Marine light kit with GFI outlet							
Door opening	Outward											
NOTES:												
Supply fan performance is certified in accordance with the Central Station Air-Handling Unit Certification Program, which is based on AHRI Standard 430.												
As a standalone component, unit meets or exceeds requirements of ASHRAE 90.1 - 1999. The approving authority is responsible for compliance of multi-component building systems.												
SHIPPING SECTION DETAILS												
	Length (inches)				Weight (lb)							
Section 1	72				2559							
Section 2	86				4256							
Section 3	24				3300							
Section 4	94				4237							
TOTALS	276.00 (Lower level total)				14352 (Entire unit weight)							
UNIT SOUND												
	63 Hz	125 Hz	250 Hz	500 Hz	1000 Hz	2000 Hz	4000 Hz	8000 Hz				
Radiated	89	94	85	78	72	63	47	38				
Unit discharge	97	102	97	95	92	86	82	74				
Unit return	92	97	89	86	78	68	57	48				

Unit Drawings

Unit drawings (below) show all opening and connection locations and are available in .dxf format for easily incorporating into project drawings.

Figure 24: 107 Extended Size Drawings

Opening	X	Y	Z	W(Width)	H(Height)
A Damper	0.00	2.00	28.00	80.00	68.00
B Damper	2.00	2.00	116.00	80.00	68.00
C Damper	0.00	86.00	28.00	80.00	68.00
D Damper	2.00	86.00	116.00	80.00	68.00
E Hot water outlet	150.57	-7.00	44.05	2.50ins. MPS	-
F Hot water inlet	150.57	-7.00	17.40	2.50ins. MPS	-
G Hot water outlet	150.57	-7.00	75.45	2.50ins. MPS	-
H Hot water inlet	150.57	-7.00	48.80	2.50ins. MPS	-
I Hot water outlet	150.57	-7.00	106.85	2.50ins. MPS	-
J Hot water inlet	150.57	-7.00	80.20	2.50ins. MPS	-
K Cold water outlet	163.29	-7.00	59.44	3.00ins. MPS	-
L Cold water inlet	167.16	-7.00	17.56	3.00ins. MPS	-
M Cold water outlet	163.29	-7.00	106.44	3.00ins. MPS	-
N Cold water inlet	167.16	-7.00 <td 64.56	3.00ins. MPS	-	
O Condensate drain conn.	170.00	-3.40	11.73	1.50ins. MPS	-
P Fan discharge	277.00	50.00	58.00	64.05	47.99

Dimensions measured from ⊕

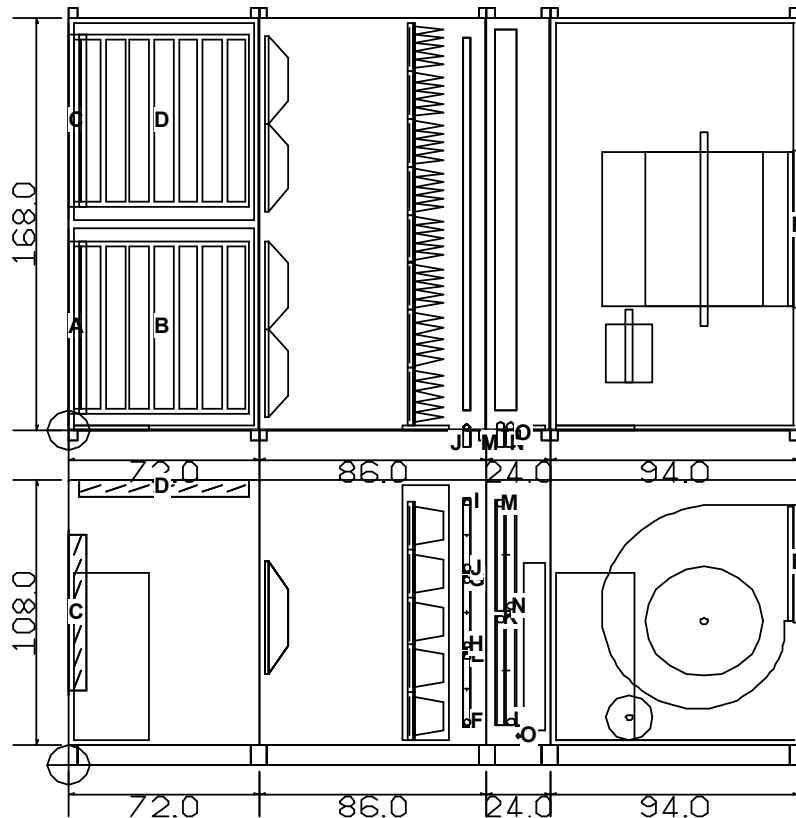

NOTE: Base 8.00ins deep, Cross members extend 4ins on each side of the unit.

VIEW: General Arrangement No Ends
 DRAWN: June-12-2008 (14:58)
 JOB NAME: Extended Sizes
 UNIT TAGGING: 107
 MODEL: CAH107GDAC

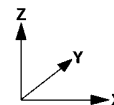
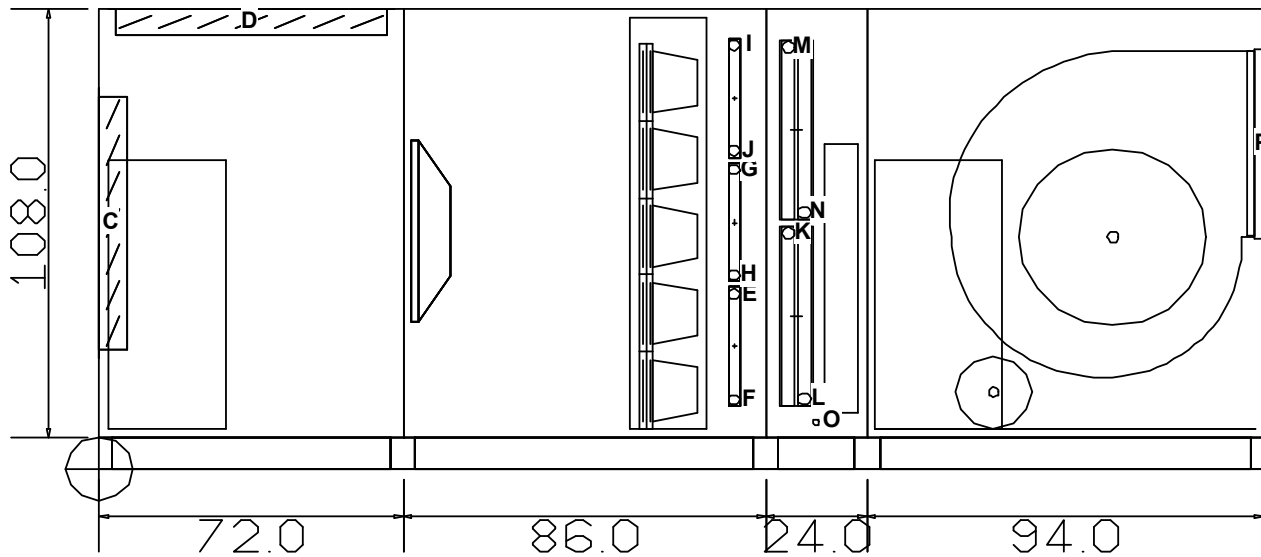

Figure 24 continued: 107 Extended Size Drawings

Opening	X	Y	Z	W(Width)	H(Height)
A Damper	0.00	2.00	28.00	80.00	68.00
B Damper	2.00	2.00	116.00	80.00	68.00
C Damper	0.00	86.00	28.00	80.00	68.00
D Damper	2.00	86.00	116.00	80.00	68.00
E Hot water outlet	150.57	-7.00	44.05	2.50ins. MPS	-
F Hot water inlet	150.57	-7.00	17.40	2.50ins. MPS	-
G Hot water outlet	150.57	-7.00	75.45	2.50ins. MPS	-
H Hot water inlet	150.57	-7.00	48.80	2.50ins. MPS	-
I Hot water outlet	150.57	-7.00	106.85	2.50ins. MPS	-
J Hot water inlet	150.57	-7.00	80.20	2.50ins. MPS	-
K Cold water outlet	163.29	-7.00	59.44	3.00ins. MPS	-
L Cold water inlet	167.16	-7.00	17.56	3.00ins. MPS	-
M Cold water outlet	163.29	-7.00	106.44	3.00ins. MPS	-
N Cold water inlet	167.16	-7.00	64.56	3.00ins. MPS	-
O Condensate drain conn.	170.00	-3.40	11.73	1.50ins. MPS	-
P Fan discharge	277.00	50.00	58.00	64.05	47.99

Dimensions measured from ⊕



NOTE: Base 8.00ins deep, Cross members extend 4ins on each side of the unit.

VIEW: Right Side
DRAWN: June-12-2008 (14:58)
JOB NAME: Extended Sizes
UNIT TAGGING: 107
MODEL: CAH107GDAC

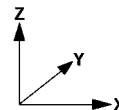
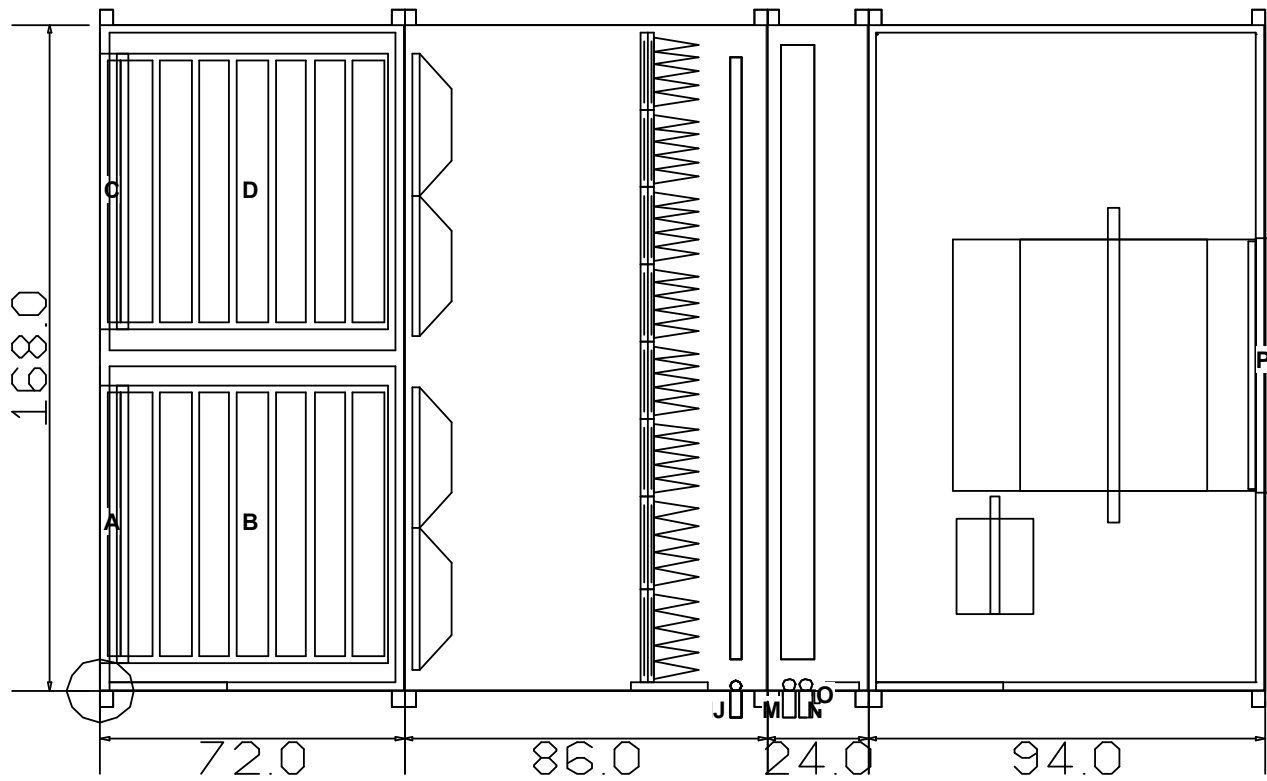

Figure 24 continued: 107 Extended Size Drawings

Opening	X	Y	Z	W(Width)	H(Height)
A Damper	0.00	2.00	28.00	80.00	68.00
B Damper	2.00	2.00	116.00	80.00	68.00
C Damper	0.00	86.00	28.00	80.00	68.00
D Damper	2.00	86.00	116.00	80.00	68.00
E Hot water outlet	150.57	-7.00	44.05	2.50ins. MPS	-
F Hot water inlet	150.57	-7.00	17.40	2.50ins. MPS	-
G Hot water outlet	150.57	-7.00	75.45	2.50ins. MPS	-
H Hot water inlet	150.57	-7.00	48.80	2.50ins. MPS	-
I Hot water outlet	150.57	-7.00	106.85	2.50ins. MPS	-
J Hot water inlet	150.57	-7.00	80.20	2.50ins. MPS	-
K Cold water outlet	163.29	-7.00	59.44	3.00ins. MPS	-
L Cold water inlet	167.16	-7.00	17.56	3.00ins. MPS	-
M Cold water outlet	163.29	-7.00	106.44	3.00ins. MPS	-
N Cold water inlet	167.16	-7.00	64.56	3.00ins. MPS	-
O Condensate drain conn.	170.00	-3.40	11.73	1.50ins. MPS	-
P Fan discharge	277.00	50.00	58.00	64.05	47.99

Dimensions measured from ⊕



NOTE: Base 8.00ins deep, Cross members extend 4ins on each side of the unit.

VIEW: Top
DRAWN: June-12-2008 (14:58)
JOB NAME: Extended Sizes
UNIT TAGGING: 107
MODEL: CAH107GDAC

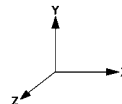

Fan Curves

Figure 25: 107 Extended Size Fan Curve

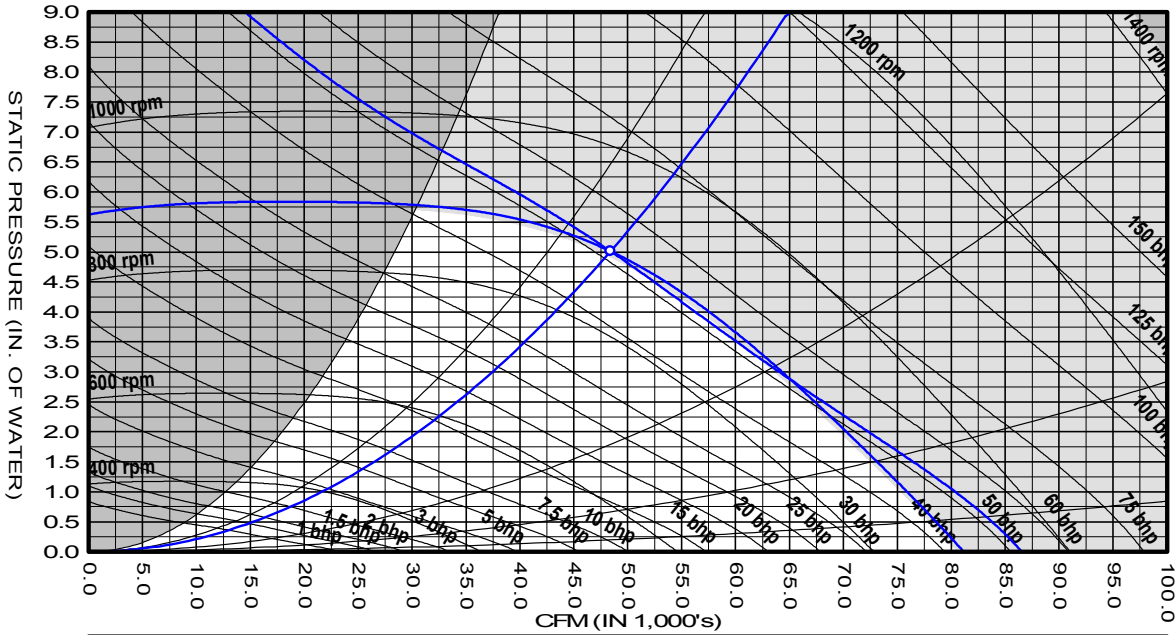

44.50" Airfoil Supply Fan at Standard Conditions					
Air volume	48400	cfm	Fan speed	892	rpm
Total static	5.01	insWg	Max speed	1146	rpm
Brake horsepower	51.8	bhp	Efficiency	73.7	%
Unit tagging	107		Date	June-12-2008	
Job name	Extended Sizes		Time	14:58	
 Supply fan performance is certified in accordance with the Central Station Air-Handling Unit Certification Program, which is based on ARI Standard 430.					

Fax Sheet

The fax sheet (below) can be used as a quick reference toward the air handler's performance.

JOB NAME	U8G064(XX.000)		REP. OFFICE	House Account					
JOB DESCRIPTION	Extended Sizes		SALESPERSON	MO					
MODEL NUMBER	CAH107GDAC		ENGINEER						
UNIT TAGGING	107		VERSION	8.74					
Unit configuration	Inline horizontal								
Supply external dimensions	(HxW) ins	108 x 168							
Exhaust external dimensions	(HxW) ins								
FAN PERFORMANCE				SUPPLY					RETURN / EXHAUST
Air volume	cfm	48400							
Altitude	ft.	0							
Turning loss	in WC	0.0							
External static	in WC	2.0							
Total static	in WC	5.01							
Fan diameter / type	ins	44.50 / AF							
Fan power	HP	51.81							
Motor power	HP	60.0							
Motor voltage	V/Hz/P	460/60/3							
COIL PERFORMANCE	In order of air flow	1st COIL	2nd COIL	3rd COIL	4th COIL				
Coil model		5WS0702C	5WM1005C						
Total capacity	Btu/hr	2654590	1937893						
Sensible capacity	Btu/hr	1351492							
Entering db / wb	°F	40.0 / —	80.0 / 67.0						
Leaving db / wb	°F	90.2 / —	54.5 / 54.0						
Face area	sq ft	95.0	96.88						
Face velocity	fpm	509	500						
Air pressure drop	in WC	0.26	1.0						
EWT / LWT	°F	160.0 / 139.9	45.0 / 55.0						
Flow rate	gpm	264.60	387.60						
Glycol type / %		- (0 %)	- (0 %)						
Water pressure drop	ftHD	8.70	18.90						
Suction temp / Refrig	°F	—	—						
Steam pressure	psig	—	—						
FILTER DATA		STAGE 1	STAGE 2	STAGE 3					
Type		Throwaway (MERV 7)	Varicel SH cartridge						
Efficiency		—	85						
Face area	sqft	109.7	109.7						
Face velocity	fpm	441	441						
COMPONENT	SUPPLY	APD (in WC)	WEIGHT (lbs)	COMPONENT	RET/EXH	APD (in WC)	WEIGHT (lbs)		
Mixing Box		0.05	541.71						
Blender		0.26	600.39						
Combination Filter		1.44	785.47						
Hot Water Coil		0.26	827.0						
Chilled Water Coil		1.0	2275.94						
Fan Section		0.0	1655.45						
** Denotes a component static pressure based on the fan air volume rather than the individual component air volume.									
SHIPPING SECTION DETAILS									
	Length (ins)	Weight (lbs)				Length (ins)	Weight (lbs)		
Section 1	72	2559							
Section 2	86	4256							
Section 3	24	3300							
Section 4	94	4237							
TOTALS (Lower level total length, entire unit total weight)						276.00	14352		
UNIT SOUND	63 Hz	125 Hz	250 Hz	500 Hz	1000 Hz	2000 Hz	4000 Hz	8000 Hz	
Radiated	89	94	85	78	72	63	47	38	
Unit discharge	97	102	97	95	92	86	82	74	
Unit return	92	97	89	86	78	68	57	48	

NOTES:

Liner material is Galvanized steel. Insulation is R-13 Injected Foam.

Supply fan performance is certified in accordance with the Central Station Air-Handling Unit Certification Program, based on AHRI Standard 430.

Supply Power Wiring

1. Units required three phase power supply.
2. Allowable voltage tolerances:
 - a. 60 Hertz
 Nameplate 208 V: Min. 187 V, max. 229 V
 Nameplate 230 V: Min. 207 V, max. 253 V
 Nameplate 460 V: Min. 414 V, max. 506 V
 Nameplate 575 V: Min. 518 V, max. 633 V

3. Minimum Circuit Ampacity (MCA) calculation:

NOTE: If a unit is provided with multiple power connections, each must be considered alone in selecting power wiring components.

For units with cooling and heating:

$$MCA = 1.25 \times \text{largest load} + \text{sum of all other loads}$$

NOTE: Control circuit ampacity does not need to be considered in the calculation for wire sizing ampacity. If the unit is provided with one or more fan section lights, they are powered from the separate 15 amp (minimum), 120 V supply required by the NEC for the unit convenience outlet.

4. Size wires in accordance with Table 310-16 or 310-19 of the National Electrical Code.
5. Wires should be sized for a maximum of 3% voltage drop.

Table 20: Recommended Power Wiring

Ampacity	No. of Power Wires Per Phase	Wire Gauge	Insulation Rating (0°C)
30	1	10	75
40	1	8	75
55	1	6	75
70	1	4	75
85	1	3	75
95	1	2	75
130	1	1	75
150	1	1/0	75
175	1	2/0	75
200	1	3/0	75
230	1	4/0	75
255	1	250	75
300	2	1/0	75
350	2	2/0	75
400	2	3/0	75
460	2	4/0	75
510	2	250	75
600	3	3/0	75
690	3	4/0	75
765	3	250	75

PART 1: GENERAL

1.01 SECTION INCLUDES

- A. Indoor air handling units.

1.02 REFERENCES

- A. AFBMA 9 - Load Ratings and Fatigue Life for Ball Bearings
- B. AMCA 99 - Standards Handbook
- C. AMCA 210 - Laboratory Methods of Testing Fans for Rating Purposes
- D. AMCA 300 - Test Code for Sound Rating Air Moving Devices
- E. AMCA 500 - Test Methods for Louver, Dampers, and Shutters
- F. AHRI 410 - Forced-Circulation Air-Cooling and Air-Heating Coils
- G. AHRI 430 - Central-Station Air-Handling Units.
- H. AHRI 435 - Application of Central-Station Air-Handling Units
- I. ASTM B117 – Standard Practice for Operating Salt Spray Apparatus
- J. NEMA MG1 - Motors and Generators.
- K. NFPA 70 - National Electrical Code.
- L. SMACNA - HVAC Duct Construction Standards - Metal and Flexible.
- M. UL 723 – Test for Surface Burning Characteristics of Building Materials
- N. UL 900 - Test Performance of Air Filter Units
- O. UL 1995 – Standard for Heating and Cooling Equipment
- P. UL 94 – Test for Flammability of Plastic Materials for Parts in Devices and Appliances
- Q. IBC 2000, 2003 – International Building Code
- R. NFPA 90A – Standard for the Installation of Air Conditioning and Ventilating Systems
- S. NFPA 5000 – Building Construction and Safety Code
- T. ASHRAE 90.1 Energy Code
- U. AHRI Standard 1060 – Rating Air-to-Air Heat Exchangers for Energy Recovery Ventilation Equipment
- V. GSA 2003 Facilities Standard - 5.9 HVAC Systems and Components

1.03 SUBMITTALS

- A. Shop Drawings: Indicate assembly, unit dimensions, weight loading, required clearances, construction details, field connection details, and electrical characteristics and connection requirements. Computer generated fan curves for each air handling unit shall be submitted with specific design operating point noted. A computer generated psychometric chart shall be submitted for each cooling coil with design points and final operating point clearly noted. Sound data for discharge, radiated and return positions shall be submitted by octave band for each unit. Calculations for required baserail heights to satisfy condensate trapping requirements of cooling coil shall be included.
- B. Product Data:
 1. Provide literature that indicates dimensions, weights, capacities, ratings, fan performance, and electrical characteristics and connection requirements.
 2. Provide data of filter media, filter performance data, filter assembly, and filter frames.
- C. Manufacturer's Installation Instructions.

1.04 QUALIFICATIONS

- A. Manufacturers specializing in manufacturing Air Handling Units specified in this section must prove minimum five years documented experience and issue a complete catalog on total product.

1.05 SAFETY AGENCY LISTED & CERTIFICATION

- A. Air handling units shall be cETLus safety listed that conforms to UL Standard 1995 and CAN/CSA Standard C22.2 No. 236. Units shall be accepted for use in New York City by the Department of Building, MEA 342-99-E.
- B. Air handler furnished with double width, double inlet (DWDI) and/or plenum fans shall be certified in accordance with the central station air handling units certification program, which is based on AHRI 430. (NOTE: Above does not apply to fan array)
- C. Air handling unit water heating & cooling coils shall be certified in accordance with the forced circulation air cooling and air heating coils certification program, which is based on AHRI Standard 410

1.06 DELIVERY, STORAGE, AND HANDLING

- A. Deliver, store, protect and handle products to site.
- B. Accept products on site in factory-fabricated protective containers, with factory-installed shipping skids. Inspect for damage.
- C. Store in clean dry place and protect from weather and construction traffic. Handle carefully to avoid damage to components, enclosures, and finish.

PART 2: PRODUCTS
2.01 MANUFACTURERS

- A. The following manufacturers are approved for use. No substitutions will be permitted.
 - 1. Daikin as basis of design
 - 2. Miller-Picking
 - 3. Temtrol
 - 4. Scott-Springfield
 - 5. Racan-Carrier Company

2.02 GENERAL DESCRIPTION

- A. Configuration: Fabricate as detailed on drawings.
- B. Performance: Conform to AHRI 430. See schedules on prints. (NOTE: Above does not apply to fan array)
- C. Acoustics: Sound power levels (dB) for the unit shall not exceed the following specified levels. The manufacturer shall provide the necessary sound treatment to meet these levels if required.

Octave Band at Center Frequency (Hz)								
	63	125	250	500	1000	2000	4000	8000
Radiated								
Discharge								
Return								

2.03 UNIT CONSTRUCTION

- A. Fabricate unit with 16 gauge channel posts and panels secured with mechanical fasteners. All panels, access doors, and ship sections shall be sealed with permanently applied bulb-type gasket. Shipped loose gasketing is not allowed.
 - 1. Panels and access doors shall be constructed as a 2-inch (50-mm) nominal thick; thermal broke double wall assembly, injected with foam insulation for an R-value of not less than R-13. The outer panel shall be constructed of G90 galvanized [G60 painted galvanized] [18-gauge] steel. The inner liner shall be constructed of G90 galvanized [solid stainless] steel.
 - 2. Panel deflection shall not exceed L/240 ratio at 125% of design static pressure, maximum positive or negative 8inches of static pressure. Deflection shall be measured at the midpoint of the panel height.
 - 3. Panel assembly shall meet UL standard 1995 for fire safety. Panel assembly shall comply with the material requirements of NFPA 90A.
 - 4. The casing leakage rate shall not exceed [0.50 cfm per square foot of casing surface area at design static pressure up to a maximum of +5" w.c. in positive pressure sections and -6" w.c. in negative pressure sections (.0025 m³/s per square meter of cabinet area at 1.24 kPa static pressure)] [ASHRAE 111 Class 6 at design static pressure up to a maximum of +8" w.c. in positive pressure sections and -8" w.c. (1.99 kPa) in negative pressure sections, where casing leakage (cfm/100 ft² of casing surface are) = CL × P^{0.65}] [1% of supply air volume at design static pressure up to a maximum of +8" w.c. in positive pressure sections and -8" w.c. (1.99 kPa) in negative pressure sections].
 - 5. Factory leakage test available for units selected with high pressure, low leakage construction. The unit manufacturer shall provide a witnessed factory leak test on selected units. The cabinet shall be tested at the unit's positive and negative maximum design operating static pressure, [up to 8" of differential static pressure across the cabinet exterior walls for the entire unit. Cabinet leakage shall not exceed Class 6 leakage per ASHRAE Standard 111 or 1% of supply air volume, whichever is greater] [up to +5"/-6" of differential static pressure across the cabinet exterior walls for the entire unit. Cabinet leakage shall not exceed 0.50 CFM/sq. ft. of casing surface area]. All supply and return opening shall be sealed. Air pressure and flow shall be measured by a third party calibrated and certified apparatus. The testing shall be performed at the factory. Owner's representative shall select on unit to be tested at the time of order. A written test report shall be prepared by the manufacturer and issued to the owner's representative

6. Factory panel deflection testing available for units selected with high pressure, low leakage construction. The unit manufacturer shall provide a factory deflection test on one unit at the unit's positive and negative maximum design operating static pressure, up to 8" of differential static pressure across the cabinet exterior walls for the entire unit. A deflection limit of L/240 will be demonstrated at this time. "L" is defined as the height of a panel on the side of the unit. Measurement shall be at the mid-point of "L" along the largest panel on one side. Owner's representative shall select on unit to be tested at the time of order. A written test report shall be prepared by the manufacturer and issued to the owner's representative.
 7. Module to module assembly shall be accomplished with an overlapping, full perimeter, internal splice joint sealed with bulb type gasketing on both mating modules to minimize on-site labor and meet indoor air quality standards.
 8. [A sound baffle shall be secured to the inner liner and constructed of G90 galvanized perforated steel filled with glass fiber insulation.]
 9. [An optional 0.044" thick aluminium treadplate shall be secured to the floor panel.]
 10. [Entire unit shall have a [8] [10] [12]-inch full perimeter base rail for structural rigidity and condensate trapping. The following calculation shall determine the required height of the baserail to allow for adequate drainage. Use the largest pressure to determine base rail height. $[(\text{Negative})(\text{Positive}) \text{ static pressure (in)}] (2) + 4" = \text{required baserail height}$. Should the unit baserail not be factory supplied at this height, the contractor is required to supply a concrete housekeeping pad to make up the difference.]
- B. Access Doors shall be flush mounted to cabinetry, with minimum of two six inch long stainless steel piano-type hinges, latch and full size (4.5" minimum) handle assembly (provide inspection window for fan section). Door shall swing outward for unit sections under negative pressure (inward for unit sections under positive pressure). Doors limited from swinging inward (such as side access filter sections) on positive pressure sections, shall have a secondary latch to relieve pressure and prevent injury upon access.
- C. Construct drain pans from stainless steel with cross break and double sloping pitch to drain connection. Provide drain pans under cooling coil section [fan section]. Drain connection centerline shall be a minimum of 3" above the base rail to aid in proper condensate trapping. Drain connections that protrude from the base rail are not acceptable. There must be a full 2" thickness of insulation under drain pan.

2.04 SUPPLY / RETURN FANS

- A. Provide [DWDI forward-curved] [DWDI airfoil] [beltdrive airfoil plenum] [direct-drive airfoil plenum] [fan array] supply [return] fan(s). Fan assemblies including fan, motor and sheaves shall be dynamically balanced by the manufacturer on all three planes and at all bearing supports. Manufacturer must ensure maximum fan RPM is below the first critical speed.

ECM fan array

1. Provide ECM, motorized impeller supply [return] fan(s). Fan assembly shall include fan, fan base, and a motor and shall be dynamically balanced by the fan manufacturer.
 - a. Inverter shall be integral to the motor and come as an assembly from the fan manufacturer.
 - b. Motor shall be brushless DC type with a permanent magnet rotor.
 - c. Fan section shall come equipped with a motor control panel mounted on the supply [return] fan section. Both line voltage and low voltage wiring shall be done by the factory. Each fan shall have an isolation switch.
 - d. [Unit shall be provided with a ship loose motor control panel for the supply [return] fan section. All motor wiring shall be field supplied and installed]
 - e. Motor control panel shall come equipped with a fused disconnect
 - f. Motor control panel shall come with a low voltage terminal strip and shall include terminals for Fan ON/OFF, 0-10V signal, and fan fault.
 - g. ECM motor control panel SCCR shall be at least 65kA
 - h. [Unit shall come equipped with an isolation damper upstream of each fan in the array. Damper shall be equipped with an adjustable, weighted counter balance to minimize static pressure loss]

DDPL fan array

1. Fan array shall have number of fans as scheduled.
2. Fan array section shall come with sound absorbing panels installed around each fan.
3. Fan array shall have fans individually isolated with [Rubber in Shear(RIS)][spring] isolation.
4. Access section placed downstream for motor access. [Section shall come installed with tread plate installed in the floor. [Section shall come with motor removal hoist installed]
5. [Unit shall be equipped with a manual block-off plate for mounting in the fan inlet][Unit shall come equipped with an isolation damper upstream of each fan in the array. Damper shall be equipped with an adjustable, weighted counter balance to minimize static pressure loss][Unit shall come equipped with an actuated damper upstream of each fan. An external signal shall close the damper in the event of a fan failure.]
6. [Fan array section shall come with an externally mounted junction box to allow for field wiring of the fan array motors]
7. [Fan section shall come equipped with motor control panel with short circuit protection complete with variable frequency drives.]
 - a. [Fan array shall be equipped with one variable frequency drive wired to all fans][Fan array shall have a redundant drive wired to all fans]
 - b. [Fan array shall be equipped with one variable frequency drive wired to all fans in a given row in the fan array.]
 - c. [Fan array shall be equipped with on variable frequency drive wired to each of the fans in the fan array]
8. [Motor control panel shall come equipped with a [fused][non-fused] disconnect switch]
9. [Fan array shall be equipped with Piezometer rings to measure airflow][One piezometer ring shall be supplied on [each fan][each row][one fan] in the fan array]

Multiple direct-drive fans

1. Unit shall have [two] [three] [9] [12] blade direct drive class II fans with [2" spring isolation] [rubber-in-shear isolation (fan sizes 36 and smaller)] [2" seismic isolation].
 2. [Manual block-off] [Isolation damper [with actuator]] mounted upstream of fan for isolation of individual fans.
 3. [Single source power motor control panel with short circuit protection and [Non-fused disconnect] [fused disconnect] [Circuit breaker] factory wired from panel to motors in conduit. Variable speed control by [McQuay brand VFD(s)] [ABB] [Danfoss].] [Fan on-off and speed control by others shall be provided.]
- B. Bearings shall be self-aligning, grease lubricated, ball or roller bearings with extended copper lubrication lines to access side of unit. Grease fittings shall be attached to the fan base assembly near access door. If not supplied at the factory, contractor shall mount copper lube lines in the field.
- C. Fan and motor shall be mounted internally on a steel base. Factory mount motor on slide base that can be slid out the side of unit if removal is required. Provide access to motor, drive, and bearings through hinged access door. Fan and motor assembly shall be mounted on [rubber-in-shear vibration type isolators inside cabinetry.] [2" deflection spring vibration type isolators inside cabinetry] [unit base, rigid mounted.] [Seismic snubbers shall be provided.]

2.05 BEARINGS AND DRIVES

(Not applicable for fan array or direct drive fans)

- A. Bearings: Basic load rating computed in accordance with AFBMA - ANSI Standards, [L-50 life at 200,000 hours – all DWDI fans] [L-50 life at 500,000 hours – DWDI fans on unit sizes 003 - 035], [L-50 life at 400,000 hours all belt-drive airfoil plenum fans and DWDI fans on unit sizes greater than 035] [L-50 life 1,000,000 hours – DWDI fans on unit sizes 003 – 035] [L-50 life at 600,000 hours – all inline fans], heavy duty pillow block type, self-aligning, grease-lubricated ball bearings.
- B. Shafts shall be solid, hot rolled steel, ground and polished, keyed to shaft, and protectively coated with lubricating oil. Hollow shafts are not acceptable.
- C. V-Belt drives shall be cast iron or steel sheaves, dynamically balanced, bored to fit shafts and keyed. [Fixed sheaves, matched belts, and drive rated based on motor horsepower] [Variable and adjustable pitch sheaves selected so required RPM is obtained with sheaves set at mid-position and rated based on motor horsepower. Contractor to furnish fixed sheaves at final RPM as determined by balancing contractor]. Minimum of 2 belts shall be provided on all fans with 10 HP motors and above. Standard drive service factor shall be [1.1 S.F. (for 1/4 HP – 7.5 HP)] [1.3 S.F. (for 10 HP and larger)], calculated based

2.06 ELECTRICAL

- A. The air handler(s) shall be ETL and ETL-Canada listed by Intertek Testing Services, Inc. Units shall conform to bi-national standard ANSI/UL Standard 1995/CSA Standard C22.2 No. 236.
- B. Wiring Termination: Provide terminal lugs to match branch circuit conductor quantities, sizes, and materials indicated. Enclosed terminal lugs in terminal box sized to NFPA 70.
- C. [Provide [marine light] [marine light and GFI receptacle] in [fan] [each] section mounted and wired to a junction box and on-off switch mounted on the outside of the cabinet.
- D. Fan motors shall be [1200] [1800] [3600] rpm, [open drip-proof (ODP)] [totally enclosed fan-cooled (TEFC)] [1800/ 1200 rpm, 2 Speed/2 Winding (ODP) (TEFC)] [1800/900 rpm, 2 Speed/1 Winding (ODP) (TEFC)] type. Motors shall be [standard efficiency.] [high efficiency to meet EPAAct requirements.] [premium efficiency.] Electrical characteristics shall be as shown in schedule.

- E. [Air handler manufacturer shall provide and mount conduit and wiring from each fan motor terminated at [an external junction box.] [a non-fused] [a fused] [a circuit breaker] type disconnect switch factory wired. The disconnect switch shall be furnished with a rotary or switch-blade type handle that can be padlocked in the 'OFF' position.] [A motor starter [IEC] [NEMA] type shall be provided.]
- F. [Air handler manufacturer shall provide and mount [Daikin] [ABB] [Danfoss] variable speed drive with electrical characteristics as shown on project schedule. [A two-contactor type bypass switch shall be provided.] [A line reactor shall be provided.]
- G. [Air handler manufacturer shall provide and mount a handoff-auto (HOA) switch.]
- H. [Air handler manufacturer shall provide and mount a [24V] [120V] transformer.]
 - I. [Manufacturer must provide ASHRAE 90.1 Energy Efficiency equation details for individual equipment to assist Building Engineer for calculating system compliance.]
 - J. [Ultraviolet Light Germicidal Irradiation (UVGI) System
 - 1. The UVGI surface irradiation system shall consist of heavy duty, factory assembled and tested light fixtures that emit short wave UVC light (200 nm – 270 nm)
 - 2. Constructed and tested for HVAC environments: UL listed at 55°F to 135°F with airflow velocities up to 1000 FPM. Independently tested to verify output and performance. UVGI system shall have UL Approval per Category Code ABQK (Accessories, Air Duct Mounted) UL Standards: UL153, UL1598 & UL1995.
 - 3. Assembly shall consist of double ended UVC florescent lamp and housing, power source and sockets shall be UL Drip proof construction.
 - 4. The enclosure shall be made of drip-proof construction from galvanized steel. The ballast shall be a self-contained electronic type. The enclosure shall include safety mechanical interlocks which do not allow the UV assembly to light unless installed on its track. The multiple UV assemblies shall connect via interlock.
 - 5. UVC Lamp shall be a standard output hot cathode, low pressure T8, double ended UVC lamp. Lamps shall be constructed with a thick wall glass of soda barium UV transparent glass with a base of metal. Lamps shall have 5.5 milligrams or less of mercury.

6. Lamps shall produce adequate UV output and operate in environments of temperatures between 55°F to 135°F. Lamps shall produce a minimum of 80% of initial UV output at end of life (9000 hours minimum).
7. Power source shall be 120 VAC 60hz. Power connections shall be via a provided j-box or line cord from one end of the UV fixture. UV fixtures shall electrically connect via interlocks.
8. Installation shall be such that the cumulative sum length of UV fixtures end-to-end shall equal the coil width +/- three (3) inches. Modular coil system shall be installed and wired so that the entire surface of the coil and drain pan is bathed by UVC. System shall be installed using "tracks" to allow UV fixture to slide into place, for ease of access during installation and annual maintenance. System shall be installed 8"-20" (14" ideal) from coil surface. System shall be installed utilizing one row of lamps for every 48" of coil height. System shall incorporate safety "cut-off" switches on access doors.
9. Approved manufacturers: UltraViolet Devices, Inc. (UVDI).

B. Water Coils:

1. Certification - Acceptable water coils are to be certified in accordance with AHRI Standard 410 and bear the AHRI label. Coils exceeding the scope of the manufacturer's certification and/or the range of AHRI's standard rating conditions will be considered provided the manufacturer is a current member of the AHRI Air-Cooling and Air-Heating Coils certification programs and that the coils have been rated in accordance with AHRI Standard 410. Manufacturer must be ISO 9002 certified.
2. Headers shall consist of seamless copper tubing to assure compatibility with primary surface. Headers to have intruded tube holes to provide maximum brazing surface for tube to header joint, strength, and inherent flexibility. Header diameter should vary with fluid flow requirements.
3. Fins shall have a minimum thickness of [[0.0075"] [0.0095"] of aluminum] or [0.006"] [0.0075"] [0.0095"] copper]] plate construction. Fins shall have full drawn collars to provide a continuous surface cover over the entire tube for maximum heat transfer. Tubes shall be mechanically expanded into the fins to provide a continuous primary to secondary compression bond over the entire finned length for maximum heat transfer rates. Bare copper tubes shall not be visible between fins.
4. Coil tubes shall be 5/8 inch (16mm) OD seamless copper, 0.020" [0.025"] [0.035"] [0.049"] nominal tube wall thickness, expanded into fins, brazed at joints. Soldered U-bends shall be provided to minimize the effects of erosion and premature failure having a minimum tube wall thickness of 0.025".
5. Coil connections shall be [N.P.T. threaded carbon steel] [butt weld carbon steel] [O.D. sweat copper] [threaded red brass] with connection size to be determined by manufacturer based upon the most efficient coil circuiting. Vent and drain fittings shall be furnished on the connections, exterior to the air handler. Vent connections provided at the highest point to assure proper venting. Drain connections shall be provided at the lowest point to ensure complete drainage and prevent freeze-up.
6. Coil casings shall be a formed channel frame of [galvanized steel] [stainless steel]. Water heating coils, 1 & 2 row only (sans 5M type) shall be furnished as uncased to allow for thermal movement and slide into a pitched track for fluid drainage.

2.07 COOLING AND HEATING COIL SECTIONS

- A. Provide access to coils from [both sides] [connection side] [opposite side] of unit for service and cleaning. Enclose coil headers and return bends fully within unit casing. Unit shall be provided with coil connections that extend a minimum of 5" beyond unit casing for ease of installation. Drain and vent connections shall be provided exterior to unit casing. Coil connections must be factory sealed with grommets on interior and exterior and gasket sleeve between outer wall and liner where each pipe extends through the unit casing to minimize air leakage and condensation inside panel assembly. If not factory packaged, Contractor must supply all coil connection grommets and sleeves. Coils shall be removable through side and/or top panels of unit without the need to remove and disassemble the entire section from the unit.
 1. Identify fin, tube & casing material type and thickness.
 2. Show coil weights (shipping & operating).
 3. State air and fluid flow amounts with its associated pressure drops. For steam coils, indicate steam pressure and condensate load.
 4. Indicate entering & leaving air and water temperatures. For refrigerant coils, indicate saturated suction temperature (SST).
 5. [Manufacturer to provide and mount ultraviolet lights on the leaving air side of the cooling coil(s) and over the drain pan to meet GSA 2003 Facilities Standard - 5.9 HVAC Systems and Components and agency approved to UL category Code ABQK specification, HVAC Accessories, Air Duct Mounted.]

C. Refrigerant Coils:

1. Manufacturer must be ISO 9002 certified.
2. Coils designed for use with Refrigerant [R-22] [R134a] [R410a] [other]. Fins shall have a minimum thickness of [[0.0075"] [0.0095"] of aluminum] or [0.006"] [0.0075"] [0.0095"] copper]] plate construction with full drawn collars to provide a continuous surface cover over the entire tube for maximum heat transfer. Tubes shall be mechanically expanded into the fins to provide a continuous primary-to-secondary compression bond over the entire finned length for maximum heat transfer rates. Bare copper tube shall not be visible between fins.
3. Refrigerant coils shall be provided with round seamless 5/8" O.D. copper tubes on 1-1/2" centers, staggered in the direction of airflow. All joints shall be brazed.
4. Sweat type copper suction connections located at the bottom of the suction headers for gravity oil drainage. Coils shall be uniformly circuited in a counterflow manner for [single circuit] [row] [face] [interlaced] [interlaced face split] capacity reduction. Pressure type liquid distributors used. Coils shall be tested with 315 pounds air pressure under warm water, and suitable for 250 psig working pressure.

D. Steam Coils:

1. Certification - Acceptable steam coils are to be certified in accordance with AHRI Standard 410 and bear the AHRI label. Coils exceeding the scope of the manufacturer's certification and/or the range of AHRI's standard rating conditions will be considered provided the manufacturer is a current member of the AHRI Air-Cooling and Air-Heating Coils certification programs and that the coils have been rated in accordance with AHRI Standard 410. Manufacturer must be ISO 9002 certified.
2. Fins shall have a minimum thickness of [[0.0075"] [0.0095"] [0.012" (1" dia. tubes only)] of aluminum] or [0.006" (5/8" tube dia. only)] [0.0075"] [0.0095"] copper]] with full drawn collars to provide a continuous surface cover over the entire tube for maximum heat transfer. Tubes shall be mechanically expanded into the fins to provide a continuous primary-to-secondary compression bond over the entire finned length for maximum heat transfer rates. Bare copper tubes shall not be visible between fins.
3. Steam coils shall be provided with round seamless [5/8" O.D. copper [0.020"] [0.025"] [0.035"] [0.049"] or [1" O.D. copper [0.025"] [0.049"] tubes. Tubes on two-row coils are staggered in the direction of airflow. All joints shall be brazed.
4. Steam coil headers shall be made of nonferrous materials using seamless copper tubing with intruded tube holes to permit expansion and contraction without creating undue stress or strain. Both the supply and return headers shall be completely encased by the coil casing. Coil shall be pitched in the unit to assure positive condensate drainage. Steam coils shall be furnished as uncased to allow for thermal movement and slide into a pitched track for drainage. Orificed baffle plates shall be installed in the supply connection to ensure proper diffusion of entering steam.
5. Steam coils shall be tested with 315 pounds air pressure under warm water and suitable for 150 psig working pressures.

- E. [Horizontal Tube Integral Face and Bypass Coil
1. Horizontal tube integral face and bypass coils shall consist of multiple alternating heating sections and bypass sections, with airflow distributed to each by interlocking wrap-a-round "clamshell" style dampers; linkage to be stainless steel. Coils shall be suitable for hot water or steam and continuous operation at 200 psig and 400 F degrees. Heating elements to consist of multi-row, multi-pass extended heat transfer surface; coil shall carry AHRI 410 certification as to ratings. Welding and brazing shall be done by ASME qualified personnel.
 2. Tubes shall be 5/8" diameter seamless copper, 0.035" average wall thickness. Fins shall be continuous patterned plate, 0.0075" thick aluminum with full fin collars. Joints shall be silver brazed.
 3. Headers shall be single piece carbon steel, with no separate disks or caps welded or brazed into header ends. Connections shall be steel and shall be welded to header barrels.
 4. Casings and dampers shall be minimum 16 gauge mill galvanized steel; top and bottom casing panels to be double flanged for stacking. End casings shall have smooth, embossed tube holes to provide adequate bearing surface for tubes to avoid abrasion during expansion and contraction. Flexible connectors shall not be required.]

- F. [Vertical Tube Integral Face and Bypass Coil
1. Vertical tube integral face and bypass coils shall consist of multiple alternating heating sections and bypass sections, with airflow distributed to each by interlocking wrap-a-round "clamshell" style dampers; linkage to be stainless steel. Coils shall be suitable for hot water or steam and continuous operation at 200 psig and 400 F degrees. Heating elements to consist of multi-row, multi-pass extended heat transfer surface; coil shall carry AHRI 410 certification as to ratings. Welding and brazing shall be done by ASME qualified personnel.
 2. Hot water applications shall be furnished with 5/8" outside diameter tubes with .035" tube wall thickness. Steam applications shall be furnished with a non-freeze, tube-within-a-tube design that consists of an outer tube that is 5/8" outside diameter tubes with 0.035" tube wall thickness and an inner tube that is 3/8" outside diameter with .020" wall thickness. Fins shall be a helical fin design that is 1/2" high, 0.012" thick copper, solder coated.

3. Supply and Return headers shall be located at the base of the coil. Hot water coils shall employ return bends. Steam coils shall be capped to allow free thermal movement. Headers shall be carbon steel with male pipe thread connections.
4. The casing shall be 12 gauge galvanized steel. The dampers shall be 16 gauge galvanized steel with aluminum hinges, stainless steel pins, linkage & connecting bars with oilite bearings.]

2.08 GAS HEAT MODULE

- A. The air handling unit shall include a natural gas heating section. The gas furnace shall be natural gas fired heating module(s) factory installed downstream of the supply air fan in the heat section.
- B. [The heating module shall be a tubular design with in-shot gas burners. The heat exchanger tubes shall be constructed of stainless steel. The module shall have an induced draft fan that will maintain a negative pressure in the heat exchanger tubes for the removal of the flue gases.] [High efficiency heat exchanger shall be a primary drum and multi-pass tubular secondary constructed of titanium stainless steel, and shall be of a floating design to minimize stresses during heating and cooling cycles. Tubing used for the heat exchanger shall comply with ASTM A268 or ASTM 249 (as applicable). Secondary tubes shall be swaged into panels and welded to provide a secure joint and air tight assembly. All heat transfer surfaces shall be inside the casing and in the air stream.]
- C. [Gas-fired duct furnaces provided shall have a tubular heat exchanger constructed of (Type 409 Stainless Steel .044 minimum wall thickness produced to ASTM A268).]
- D. [Duct furnace to provide a minimum combustion efficiency of 90% through the entire firing range, exceeding the ASHRAE 90.1 minimum requirement for steady state efficiency.]
- E. [High efficiency gas heat section shall be provided with condensate drain(s). Installer is responsible for materials and final connection of drain(s) for condensate disposal.]
- F. [High efficiency furnaces require a Category IV venting system certified to UL 1738 / ULC S636. Installer is responsible for material and final vent installation in accordance with manufactures instructions provided.]
- G. The Duct Furnace models shall be listed by Intertek Testing Services (ITS / ETL) for operation on Natural or Propane gas to the current edition of ANSI Z83.8 Standard for Gas-Fired Duct Furnaces. Duct furnaces are for installation on the positive pressure side of the circulating air blower, only.
- H. [Gas Module shall be [2] [4] stages of control] [Gas module shall have [5:1] [10:1] [20:1] [25:1] modulating control.]

- I. Each burner module shall have [two flame roll-out safety protection switches and] a high temperature limit switch that will shut the gas valve off upon detection of improper burner manifold operation.
- J. The induced draft fan shall have an airflow safety switch that will prevent the heating module from turning on in the event of no airflow in the flue chamber.
- K. Field installed heating modules shall require a field ETL certification. The manufacturer's rooftop unit ETL certification shall cover the complete unit including the gas heating modules.
- L. Individual Duct Furnaces shall incorporate a Direct Spark Ignition control module that is design certified by a recognized national testing agency. The control shall provide:
 - 1. 100% safety shut-off
 - 2. A 15 second minimum pre-purge period prior to trial for ignition
 - 3. High energy direct spark ignition of main burners
 - 4. Electronic flame supervision incorporating a 0.8 second flame failure response time
 - 5. Up to 2 additional ignition retries preceded by an interpurge period
 - 6. A minimum 30 second post-purge
 - 7. Automatic reset after one hour to initiate additional ignition trials if lockout occurs during heat call
 - 8. An LED indicator light to provide a flash code to identify the operating condition of the control

2.09 PARTICULATE FILTERS

- A. [Filter section with filter racks and guides with hinged and latching access doors on either, or both sides, for side loading and removal of filters] [Filter section with front loading frames and clips].
- B. Filter media shall be UL 900 listed, Class I or Class II.
- C. [Flat] [Angle] arrangement with [2", 50mm] [4", 100mm] deep [pleated] [disposable] panel filters.
- D. [Bag] [Cartridge] type arrangement with holding frames suitable for [2" (50 mm)], [4" (100 mm)] prefilter and final filter media and blank-off sheets, extended surface [bag] [cartridge] media filters with [60-65] [80-85] [90-95] percent dust spot efficiency. Bag filter media [12" (305 mm)] [15" (381 mm)] [19" (483 mm)] [22" (559 mm)] [30" (762 mm)] [36" (914 mm)] deep. Cartridge filter media is [4" (50 mm)] [12" (305 mm)] deep. [Provide microbial resistant Intersept® coating on all filters.] Designed for [side] [front] loading of filters.
- E. [Furnish combination filter section with 2-inch flat pre-filter and 12-inch HEPA - 99.97% coefficient (MERV 16) final filter. Provide front-loading and removal of filters. Filter media shall be UL 900 listed, Class I or Class II.]

- F. [Manufacturer shall supply minihelic gauge to read pressure drop across the filter bank for scheduling filter replacement. Design shall be equal to a Dwyer Minihelic 2 and be recessed into the cabinet to minimize chances for damage during shipment and installation.]
- G. [Manufacturer to provide and mount ultraviolet lights on the entering air side of the filter. Ultraviolet lights must meet agency approved to UL category Code ABQK specification, HVAC Accessories, Air Duct Mounted.]

2.10 [GAS-PHASE FILTRATION

- A. Side access tracks shall accommodate AAF International's [Cleanroom Grade (CG)] [Medium Duty (MD)] [Heavy Duty (HD)] gas-phase filter cassettes.
- B. The filter enclosure shall include side access extruded aluminum tracks to support the gas phase filter cassettes. Each gas phase filter shall be supported by two upper and lower extruded aluminum tracks i.e. two support tracks at the inlet face and two support and sealing tracks at the outlet face.
- C. These tracks shall incorporate formed profile features to ensure that the filters are properly sealed into the enclosure. Simple 'L' tracks or angle supports that permit high leakage and inefficient sealing integrity are not permitted. The filter tracks shall ensure that the gas phase filter cassettes are permanently fixed in position and sealed to minimize bypass of air around the filters and to ensure that the entire contaminated air-stream passes through the filters.
- D. Each filter track shall include two hard-extruded type POM plastic strips embedded into, and protruding above, the horizontal surface of the track. These strips will minimize the surface area in contact with the filter cassettes and provide a plastic sliding surface with inherent lubricating properties to minimize friction and facilitate ease of installation and removal when sliding the gas phase filters into and out of the tracks.
- E. The filter outlet face (or downstream) upper and lower support and sealing tracks will each include a tubular, compressible, EPDM gasket inserted into a formed cavity in the sealing face of the track. Each of these tracks shall also include a vertical extruded aluminum flange that shall guide the gas phase filter into position and position the filter to guarantee that the tubular gasket is adequately compressed to seal between the filter and the track to minimize any by-pass of unfiltered air. The tubular gasket shall be treated with a polymer coating to reduce friction when sliding the gas phase filter into the track.
- F. The vertical flange in the track shall fit into notches located on the gas phase filter cassette and ensure that the cassette is properly positioned in the track. The tubular gasket shall be compressed by the action of installing the gas phase cassette into the side access tracks.

- G. The cassette shall be formed completely from injection molded, recyclable (or incinerable), high-impact polystyrene (HIPS). The plastic components that form the cassette shall be connected together using internal high pressure, snap-lock connectors formed into the connecting components. No glues or solvents shall be allowed to be used in the manufacture or construction of the cassette to prevent contamination of both the chemical media and the air-stream by off-gassing of VOCs.
- H. All surfaces of the cassette should be true and offer external squareness. The cassette construction shall be of precision close tolerance construction having external dimensional and square ness tolerances of +/- 2mm. The cassette shall be capable of operating effectively in humidity range of 5% - 99% and temperature range of -5°F (-20°C) to 130°F (55°C).
- I. Chemical media shall be supported between aerodynamically tapered screens with very low drag coefficient (for energy efficiency). Injection molded high-impact polystyrene screens shall form individual media beds assembled into a V-bank configuration.
- J. No nose cavities shall be allowed in cassettes. The inlet and outlet screens shall be parallel and the inlet and outlet face areas shall be equal to ensure equal and complete utilization of the chemical media. The screen openings shall have a maximum width of 2-mm to ensure full retention of the chemical media and to eliminate downstream fouling.
- K. The screens shall be structurally reinforced with molded plastic ribs to minimize deflection of the screen caused by the weight of the chemical media. The ribs shall span in both directions and shall be orthogonal to each other. The inlet and outlet screens shall have a minimum thickness of 1.90-mm. A spacer shall be utilized at 150-mm intervals to accurately distance the two screens and maintain squareness and a constant bed depth after filling with chemical media.
- L. The side plates of the cassette shall be completely flat and planar and without protrusions to ensure that adjacent cassette mate accurately. All flanges shall be internal. No external flanges shall used. A 25mm wide gasket shall be mounted on each side plate to seal between adjacent cassettes. A scribed line formed into the side plate during molding shall determine the accurate positioning of the gasket. The gasket shall extend completely from the bottom to the top of the side plate and the edge of the gasket shall be contiguous with the face of the cassette. The gasket material shall be adhesive coated (with an acryl-based adhesive), semi-closed-cell EPDM foam and shall have a Durometer of 50-70. The material shall have good resistance to UV, humidity, high and low temperatures, and chemicals such as acids and alkalis, and fats and grease.
- M. M A V-shaped Butterfly® Gasket shall be located horizontally along the upper and lower edges of the air leaving, or sealing, face of the cassette when the cassette is oriented for horizontal airflow. Two (2) 10-mm long, 0.5-mm thick, flexible “wings” shall be molded into a 16-mm wide, 1.5mm thick, base. When the cassette is installed the wings of the Butterfly gasket shall engage and envelop the tubular gasket that is installed in the extruded aluminum track providing a complete seal. The Butterfly gasket shall be extruded Polyurethane plastic.
- N. No heavy metals (such as Cadmium) nor regulated substances, such as CFC’s and halogen gases shall be used during the manufacturing process nor be contained in the product itself.
- O. Cassette side plates shall not incorporate the cassette filling ports. Chemical media filling ports shall be located on the face of the cassette. The ports shall be covered and sealed using reinforced injection molded polypropylene covers. The covers shall be fixed to the cassette at a minimum of three locations, being each end and in the center, with high strength, bayonet style, plastic rivets. The bayonet shall cause the rivet to expand and form a tight connection. The end of the bayonet shall be barbed to prevent withdrawal and loosening of the connection, it shall also completely plug the center of the rivet and prevent air leakage through the rivet.
- P. The sealing perimeter of the cassette face shall be completely planar with top, bottom and side flange faces being completely flush. No setbacks or gaps shall be allowed. The outer edges of the top and bottom flanges shall be completely flush with the top and bottom surfaces of the cassette.
- Q. The cassette shall include a precision molded slot positioned to accept a guide located on the surface of the support track. The slot and guide combination will ensure that the cassette is accurately positioned in the mounting track ensuring full contact and proper compression of the track-mounted gasket.
- R. Physical characteristics and performance shall be as follows: [Cleanroom Grade (CG) Cassette – Nominal size 24”H × 12”W × 12”D with media holding capacity of 0.7 cubic feet in a 1” thick ‘V’ bank arrangement. Rated pressure drop at 500 fpm shall be [.047 utilizing SAAFOxidant] [0.56 utilizing SAAFCarb] [0.57 utilizing SAAFBlend] Chemical Media. Chemical media utilization index shall be 92% or greater.]
 [Medium Duty (MD) Cassette – Nominal size 6”H × 24”W × 18”D with media holding capacity of 0.5 cubic feet in a 1” thick ‘V’ bank arrangement. Rated pressure drop at 500 fpm shall be [.031 utilizing SAAFOxidant] [0.35 utilizing SAAFCarb] [0.34 utilizing SAAFBlend] Chemical Media. Chemical media utilization index shall be 92% or greater.]
 [Heavy Duty (HD) Cassette – Nominal size 12”H × 24”W × 12”D with media holding capacity of 1.0 cubic feet in a 3” thick ‘V’ bank arrangement. Rated pressure drop at 250 fpm shall be [.073 utilizing SAAFOxidant] [0.87 utilizing SAAFCarb] [0.97 utilizing SAAFBlend] Chemical Media. Chemical media utilization index shall be 92% or greater.]

2.11 ADDITIONAL SECTIONS

- A. [Mixing box section shall be provided with [end] [top] [bottom] [left] [right] [no] outside air opening and [end] [top] [bottom] [left] [right] [no] return air opening.
1. [Outside air] [Return air] damper[s] shall be low leak, hollow core galvanized steel airfoil blades, fully gasketed and have continuous vinyl seals between damper blades in a galvanized steel frame. Dampers shall have stainless steel jamb seals along end of dampers. Connecting linkage and ABS plastic end caps shall be provided when return and outside air dampers are each sized for full airflow. Return and outside air dampers of different sizes must be driven separately. Damper Leakage: Leakage rate shall be less than two tenths of one percent leakage at 2 inches static pressure differential. Leakage rate tested in accordance with AMCA Standard 500.
 2. [Outside air] [Return air] damper[s] shall be Tamco 9000, [parallel] [opposed] blade, thermally insulated control damper. Return and outside air dampers must be driven separately.
 - a. Extruded aluminum (6063-T5) damper frame is not less than 0.080" (2.03 mm) in thickness. Damper frame is 4" (101.6 mm) deep × 1" (25.4 mm), with mounting flanges on both sides of frame.
 - b. Blades are extruded aluminum (6063-T5) airfoil profiles, internally insulated with expanded polyurethane foam and thermally broken. Complete blade has an insulating factor of R-2.29 and a temperature index of 55 (tested to AAMA 1502.7 Test Method).
 - c. Blade seals are extruded EPDM. Frame seals are extruded silicone. Seals are secured in an integral slot within the aluminum extrusions. Blade and frame seals are mechanically fastened to prevent shrinkage and movement over the life of the damper.
 - d. Bearings are composed of a Celcon inner bearing (fixed around a 7/16" (11.11 mm) aluminum hexagon blade pivot pin) rotating within a polycarbonate outer bearing inserted in the frame. This eliminates action between metal-to-metal or metal-to-plastic riding surfaces.
 - e. Adjustable 7/16" (11.11 mm) hexagonal drive rod, U-bolt fastener, and hexagonal retaining nuts are zinc-plated steel. These provide a positive connection to blades and linkage.
 - f. Aluminum and corrosion-resistant zinc-plated steel linkage hardware is installed in the frame side, complete with cup-point trunnion screws for a slip-proof grip.
 - g. Dampers are designed for operation in temperatures ranging from -40°F (-40°C) to 212°F (100°C).
 3. [Outside air] [Return air] damper[s] shall be Tamco 1000, [parallel] [opposed] blade, low leak airfoil control damper. Return and outside air dampers must be driven separately.
 - a. Extruded aluminum (6063-T5) damper frame is not less than 0.080" (2.03 mm) in thickness. Damper frame is 4" (101.6 mm) deep × 1" (25.4 mm), with mounting flanges on both sides of frame.
 - b. Blades are extruded aluminum (6063-T5) airfoil profiles.
 - c. Blade seals are extruded EPDM. Frame seals are extruded silicone. Seals are secured in an integral slot within the aluminum extrusions. Blade and frame seals are mechanically fastened to prevent shrinkage and movement over the life of the damper.
 - d. Bearings are composed of a Celcon inner bearing (fixed around a 7/16" (11.11 mm) aluminum hexagon blade pivot pin) rotating within a polycarbonate outer bearing inserted in the frame. This eliminates action between metal-to-metal or metal-to-plastic riding surfaces.
 - e. Adjustable 7/16" (11.11 mm) hexagonal drive rod, U-bolt fastener, and hexagonal retaining nuts are zinc-plated steel. These provide a positive connection to blades and linkage.
 - f. Aluminum and corrosion-resistant zinc-plated steel linkage hardware is installed in the frame side, complete with cup-point trunnion screws for a slip-proof grip.
 - g. Dampers are designed for operation in temperatures ranging from -40°F (-40°C) to 212°F (100°C).
 - h. Leakage Class 1A at 1 in w.g. (0.25 kPa) static pressure differential. Standard air leakage data is certified under the AMCA Certified Ratings Program.
 - i. Dampers are custom made to required size, without blanking off free area.

4. [Outside air] [Return air] damper[s] shall be Ruskin CD60, [parallel] [opposed] blade, low leak airfoil control damper. Return and outside air dampers must be driven separately.
 - a. Control dampers shall be produced in an ISO9001 certified factory.
 - b. Frame shall be one-piece uniframe construction of 16 ga. (1.6) galvanized steel roll formed hat channel structurally equivalent to a minimum 13 ga. (2.4) frame.
 - c. Blades shall be 14 ga. (2.0) equivalent galvanized steel, roll-formed airfoil type for low pressure drop and low noise generation.
 - d. Blade edge seals shall be Ruskiprene™ TPV type or equivalent mechanically locked into the blade edge. Adhesive or clip-on type seals are unacceptable.
 - e. Jamb seals shall be stainless steel chambered compression type to prevent leakage between blade end and damper frame. Blade end overlapping frame is unacceptable.
 - f. Multiple section dampers must have factory installed jackshafts unless clearly eliminated by engineer.
 - g. Bearings shall be 304 stainless steel, oil impregnated, and self-lubricating sleeve type with a 450 pound (204 kg) minimum radial crush load. Bearings shall turn in extruded holes in the damper frame.
 - h. Axles shall be hexagonal positively locked into the damper blade.
 - i. Linkage shall be concealed out of airstream, within the damper frame to reduce pressure drop and noise.
 - j. Temperature limits shall be -72°(-58°C) to +275°F (+135°C).
 - k. Damper shall be tested and licensed in accordance with AMCA 511 for Air Performance and Air Leakage.
 - l. Damper widths from 12" to 60" (305 to 1524) wide shall not leak any greater than 3 cfm/sq.ft. at 1" w.g. (15.2 l/s-m² at .25 kPa).

5. [Outside air] [Return air] damper[s] shall be Greenheck VCD33 [stainless steel] [galvanized], [parallel] [opposed] blade, low leak airfoil control damper. Return and outside air dampers must be driven separately.
 - a. Dampers shall consist of: a 16 ga. (1.5mm) [galvanized steel] [304 stainless steel] channel frame with 5 in. (127mm) depth; airfoil shaped, [galvanized steel] [304 stainless steel] double skin construction blades (14 ga. [2mm] equivalent thickness); blades shall be completely symmetrical relative to their axle pivot point, presenting identical resistance to airflow in either direction or pressure on either side of the damper; 1/2 in. (6mm) dia. plated steel axles turning in synthetic (acetal) sleeve bearings; TPE blade seals for 200°F (93°C) maximum temperature; flexible stainless steel jamb seals; and external (out of the airstream) blade-to-blade linkage.

6. [Outside air] [Return air] damper[s] shall be Greenheck VCD43 aluminum, [parallel] [opposed] blade, low leak airfoil control damper. Return and outside air dampers must be driven separately.
 - a. Dampers shall consist of: heavy gauge aluminum frame (0.125 in. [3.2mm] thick) with 5 in. (127mm) depth formed into a structural hat channel shape; airfoil shaped, extruded aluminum blades (0.063 in. [1.6mm] thick) with metal blade to blade overlap (seal to seal only contact is not acceptable); blades shall be completely symmetrical relative to their axle pivot point, presenting identical resistance to airflow and operation in either direction through the damper (blades that are non-symmetrical relative to their axle pivot point or utilize blade stops larger than 1/2 in. (13mm) are unacceptable); 1/2 in. (13mm) dia. plated steel axles turning in synthetic (acetal) sleeve bearings; TPE blade seals; flexible stainless steel jamb seals; and external (out of the airstream) blade-to-blade linkage.

7. [Outside air] [Return air] opening[s] shall be provided without a damper.]

- B. [Economizer section shall be provided with [end] [top] [bottom] [left] [right] [internal] [no] outside air opening, [end] [top] [bottom] [left] [right] [internal] [no] return air opening and [end] [top] [bottom] [left] [right] [internal] [no] exhaust air opening.
1. [Outside air] [Return air] [Exhaust air] damper[s] shall be low leak, hollow core galvanized steel airfoil blades, fully gasketed and have continuous vinyl seals between damper blades in a galvanized steel frame. Dampers shall have stainless steel jamb seals along end of dampers. Linkage and ABS plastic end caps shall be provided when return and outside air dampers sized for full airflow. Return and outside air dampers of different sizes or very large dampers and exhaust dampers must be driven separately. Damper Leakage: Leakage rate shall be less than two tenths of one percent leakage at 2 inches static pressure differential. Leakage rate tested in accordance with AMCA Standard 500.
 2. [Outside air] [Return air] [Exhaust air] damper[s] shall be Tamco 9000, [parallel] [opposed] blade, thermally insulated control damper. Return, outside, and exhaust air dampers must be driven separately.
 - a. Extruded aluminum (6063-T5) damper frame is not less than 0.080" (2.03 mm) in thickness. Damper frame is 4" (101.6 mm) deep × 1" (25.4 mm), with mounting flanges on both sides of frame.
 - b. Blades are extruded aluminum (6063-T5) airfoil profiles, internally insulated with expanded polyurethane foam and thermally broken. Complete blade has an insulating factor of R-2.29 and a temperature index of 55 (tested to AAMA 1502.7 Test Method).
 - c. Blade seals are extruded EPDM. Frame seals are extruded silicone. Seals are secured in an integral slot within the aluminum extrusions. Blade and frame seals are mechanically fastened to prevent shrinkage and movement over the life of the damper.
 - d. Bearings are composed of a Celcon inner bearing (fixed around a 7/16" (11.11 mm) aluminum hexagon blade pivot pin) rotating within a polycarbonate outer bearing inserted in the frame. This eliminates action between metal-to-metal or metal-to-plastic riding surfaces.
 - e. Adjustable 7/16" (11.11 mm) hexagonal drive rod, U-bolt fastener, and hexagonal retaining nuts are zinc-plated steel. These provide a positive connection to blades and linkage.
 - f. Aluminum and corrosion-resistant zinc-plated steel linkage hardware is installed in the frame side, complete with cup-point trunnion screws for a slip-proof grip.
 - g. Dampers are designed for operation in temperatures ranging from -40°F (-40°C) to 212°F (100°C).
 3. [Outside air] [Return air] [Exhaust air] damper[s] shall be Tamco 1000, [parallel] [opposed] blade, low leak airfoil control damper. Return, outside, and exhaust air dampers must be driven separately.
 - a. Extruded aluminum (6063-T5) damper frame is not less than 0.080" (2.03 mm) in thickness. Damper frame is 4" (101.6 mm) deep × 1" (25.4 mm), with mounting flanges on both sides of frame.
 - b. Blades are extruded aluminum (6063-T5) airfoil profiles.
 - c. Blade seals are extruded EPDM. Frame seals are extruded silicone. Seals are secured in an integral slot within the aluminum extrusions. Blade and frame seals are mechanically fastened to prevent shrinkage and movement over the life of the damper.
 - d. Bearings are composed of a Celcon inner bearing (fixed around a 7/16" (11.11 mm) aluminum hexagon blade pivot pin) rotating within a polycarbonate outer bearing inserted in the frame. This eliminates action between metal-to-metal or metal-to-plastic riding surfaces.
 - e. Adjustable 7/16" (11.11 mm) hexagonal drive rod, U-bolt fastener, and hexagonal retaining nuts are zinc-plated steel. These provide a positive connection to blades and linkage.
 - f. Aluminum and corrosion-resistant zinc-plated steel linkage hardware is installed in the frame side, complete with cup-point trunnion screws for a slip-proof grip.
 - g. Dampers are designed for operation in temperatures ranging from -40°F (-40°C) to 212°F (100°C).
 - h. Leakage Class 1A at 1 in w.g. (0.25 kPa) static pressure differential. Standard air leakage data is certified under the AMCA Certified Ratings Program.
 - i. Dampers are custom made to required size, without blanking off free area.
 - h. Leakage Class 1A at 1 in w.g. (0.25 kPa) static pressure differential. Standard air leakage data is certified under the AMCA Certified Ratings Program.
 - i. Dampers are custom made to required size, without blanking off free area.

4. [Outside air] [Return air] [Exhaust air] damper[s] shall be Ruskin CD60, [parallel] [opposed] blade, low leak airfoil control damper. Return, outside, and exhaust air dampers must be driven separately.
 - a. Control dampers shall be produced in an ISO9001 certified factory.
 - b. Frame shall be one-piece uniframe construction of 16 ga. (1.6) galvanized steel roll formed hat channel structurally equivalent to a minimum 13 ga. (2.4) frame.
 - c. Blades shall be 14 ga. (2.0) equivalent galvanized steel, roll-formed airfoil type for low pressure drop and low noise generation.
 - d. Blade edge seals shall be Ruskiprene™ TPV type or equivalent mechanically locked into the blade edge. Adhesive or clip-on type seals are unacceptable.
 - e. Jamb seals shall be stainless steel chambered compression type to prevent leakage between blade end and damper frame. Blade end overlapping frame is unacceptable.
 - f. Multiple section dampers must have factory installed jackshafts unless clearly eliminated by engineer.
 - g. Bearings shall be 304 stainless steel, oil impregnated, and self-lubricating sleeve type with a 450 pound (204 kg) minimum radial crush load. Bearings shall turn in extruded holes in the damper frame.
 - h. Axles shall be hexagonal positively locked into the damper blade.
 - i. Linkage shall be concealed out of airstream, within the damper frame to reduce pressure drop and noise.
 - j. Temperature limits shall be -72°(-58°C) to +275°F (+135°C).
 - k. Damper shall be tested and licensed in accordance with AMCA 511 for Air Performance and Air Leakage.
 - l. Damper widths from 12" to 60" (305 to 1524) wide shall not leak any greater than 3 cfm/sq.ft. at 1" w.g. (15.2 l/s-m² at .25 kPa).

5. [Outside air] [Return air] [Exhaust air] damper[s] shall be Greenheck VCD33 [stainless steel] [galvanized], [parallel] [opposed] blade, low leak airfoil control damper. Return, outside, and exhaust air dampers must be driven separately.
 - a. Dampers shall consist of: a 16 ga. (1.5mm) [galvanized steel] [304 stainless steel] channel frame with 5 in. (127mm) depth; airfoil shaped, [galvanized steel] [304 stainless steel] double skin construction blades (14 ga. [2mm] equivalent thickness); blades shall be completely symmetrical relative to their axle pivot point, presenting identical resistance to airflow in either direction or pressure on either side of the damper; 1/2 in. (6mm) dia. plated steel axles turning in synthetic (acetal) sleeve bearings; TPE blade seals for 200°F (93°C) maximum temperature; flexible stainless steel jamb seals; and external (out of the airstream) blade-to-blade linkage.

6. [Outside air] [Return air] [Exhaust air] damper[s] shall be Greenheck VCD43 aluminum, [parallel] [opposed] blade, low leak airfoil control damper. Return, outside, and exhaust air dampers must be driven separately.
 - a. Dampers shall consist of: heavy gauge aluminum frame (0.125 in. [3.2mm] thick) with 5 in. (127mm) depth formed into a structural hat channel shape; airfoil shaped, extruded aluminum blades (0.063 in. [1.6mm] thick) with metal blade to blade overlap (seal to seal only contact is not acceptable); blades shall be completely symmetrical relative to their axle pivot point, presenting identical resistance to airflow and operation in either direction through the damper (blades that are non-symmetrical relative to their axle pivot point or utilize blade stops larger than 1/2 in. (13mm) are unacceptable); 1/2 in. (13mm) dia. plated steel axles turning in synthetic (acetal) sleeve bearings; TPE blade seals; flexible stainless steel jamb seals; and external (out of the airstream) blade-to-blade linkage.

7. [Outside air] [Return air] [Exhaust air] opening[s] shall be provided without a damper.]

- C. [Access section shall provide access between components shall be a minimum of [16" (406mm)] [24" (610mm)] [30" (762mm)] [36" (914mm)] [42" (1067mm)] [48" (1219mm)] [54" (1372mm)] deep. Access doors of galvanized steel for flush mounting, with gasket, latch and full size (minimum of 4.5") handle assembly. [Provide stainless steel drip pan in access section.] [Floor shall be lined with 0.125-inch aluminum tread plate to accommodate walk-in weight of service technician.]

- D. [Diffuser section shall be mounted on leaving side of supply fan section providing uniform air distribution across downstream components. Perforated diffuser plate shall be secured over blast area of fan to disperse airflow.]
- E. [Blender / air mixer section to provide proper air mixing and distribution of the outside and return airstreams. Proper spacing provided in the direction of airflow as recommended by the blender manufacturer (Blender Products or Kees).]
- F. [Sound attenuator section(s) shall be provided by the air handling unit manufacturer as an integral section of the unit to attenuate fan noise at the source. Provide acoustic performance and air pressure drop as scheduled. Silencer acoustic insulation shall be covered with perforated sheet metal. [Provide [mylar] [tedlar] [fiberglass cloth] liner between perforated sheet metal and acoustic insulation].]
- G. [Manual section shall be provided by the air handling unit manufacturer as an integral section of the unit for field installation of special components. Section length to be determined by component supplier.]
- H. [[Inlet] [Discharge] plenum section shall be provided as the [first] [last] section in the direction of airflow. The plenum shall provide single or multiple [top] [end] [bottom] openings.]
- I. [Face and bypass section shall be provided to modulate airflow through and around heat transfer coils. Dampers shall be an integral part of the unit assembly. [Internal face and bypass shall be contained in the standard cabinet height] [External face and bypass arrangement shall be provided with factory provided bypass duct of same cabinet construction as the remainder of the unit. Field installed bypass ducts are not acceptable]. Blank-off and division sheets, internal linkage, access [panel] [doors] installed by unit manufacturer. Face and bypass dampers shall be of low leak design, opposed blade, with vinyl bulb edging and stainless steel edge seals, galvanized steel frame and axles in self-lubricating nylon bearings.]
- J. [Humidifier Steam Dispersion Panel (Short Absorption Manifold, SAM-e)
 1. Short Absorption Manifold designed for atmospheric steam humidifiers or pressurized steam from a boiler, to directly inject the steam into ducted air for humidification. Performance shall be factory selected based on scheduled criteria.
 2. Absorption distance characteristic shall prevent water accumulation on any surfaces beyond the drain pan downstream of the steam dispersion panel.
 3. Steam dispersion panel consisting of a (one) horizontal stainless steel header supplying steam to a bank of closely spaced vertical tubes, as necessary to meet absorption distance requirements, and to reduce condensation losses.
 4. Dual header systems creating unnecessary condensation or systems needing to be installed on a partition or requiring blank off plates are not acceptable.
 5. Header design shall be round tube to minimize pressure drop. Square headers are not acceptable.
 6. Steam inlet and condensate return located on the same side and at the bottom of the header to allow single point entry and floor mounting.
 7. Headers shall be 304 stainless steel construction.
 8. Vertical 304 stainless steel distribution tubes shall be provided to promote condensate evacuation. Horizontal distributor tubes are not acceptable.
 9. Distribution tubes shall include threaded standoffs for trouble free attachment to factory supplied support bracket.
 10. Stainless steel nozzle inserts ensure condensate free steam is discharged from the center of the distribution tubes. Systems without nozzle inserts, or other than stainless steel, are not acceptable.
 11. Stainless steel nozzle inserts shall have metered orifices, sized to provide even distribution of the discharged steam, spaced for optimum steam absorption.
 12. Comply with AHRI 640, "Standard for Commercial and Industrial Humidifiers."]

K. [Energy Recovery]

1. [Fixed Plate air-to-air heat exchanger shall be constructed of rigid thermally bonded plates separated by aluminum spacers. Exposed folded or crimped edges are not acceptable. The exchanger corrugations shall be bonded to the flat plates with a thermal adhesive and be capable of withstanding pressure differentials of up to 15" w.g. without deforming air passages. The entire heat transfer surface shall be capable of visible inspection and cleaning. Factory personnel shall calculate fixed plate temperature and pressure drop performance.]
2. [Energy recovery wheel shall be constructed of corrugated synthetic fibrous media, with a desiccant intimately bound and uniformly and permanently dispersed throughout the matrix structure of the media. Rotors with desiccants coated bonded, or synthesized onto the media are not acceptable due to delaminating or erosion of the desiccant material. Media shall be synthetic to provide corrosion resistance and resistance against attack from laboratory chemicals present in pharmaceutical, hospital, etc. environments as well as attack from external outdoor air conditions. Coated aluminum is not acceptable. Face flatness of the wheel shall be maximized in order to minimize wear on inner seal surfaces and to minimize cross leakage. Rotor shall be constructed of alternating layers of flat and corrugated media. Wheel layers should be uniform in construction forming uniform aperture sizes for airflow. Wheel construction shall be fluted or formed honeycomb geometry so as to eliminate internal wheel bypass. Wheel layers that can be separated or spread apart by airflow are unacceptable due to the possibility of channeling and performance degradation. The minimum acceptable performance shall be as specified in the unit schedule.]

Desiccant Material: The desiccant material shall be a molecular sieve, and specifically a 4A or smaller molecular sieve to minimize cross contamination.

Wheel Media Support System: The wheel frames shall consist of evenly spaced steel spokes, galvanized steel outer band and rigid center hub. The wheel construction should allow for post fabrication wheel alignment.

Wheel Seals: The wheel seals shall be full contact nylon brush seals or equivalent. Seals should be easily adjustable.

Wheel cassette: Cassettes shall be fabricated of heavy duty reinforced galvanized steel or welded structural box tubing. [Cassettes shall have a built in adjustable purge section minimizing cross contamination of supply air.] Bearings shall be inboard, zero maintenance, permanently sealed roller bearings, or alternatively, external flanged or pillow block bearings.

Drive systems shall consist of fractional horsepower AC drive motors with multi-link drive belts.

[Bypass dampers shall be furnished.]

Certification: The wheel shall be AHRI certified by the energy recovery wheel supplier to AHRI Standard 1060 and must bear the AHRI certification stamp. Private independent testing performed "in accordance with" various standards is not a substitute for AHRI certification and shall not be accepted. The wheel shall be listed or recognized by UL or equivalent.]

3. [Energy recovery wheel heat exchanger shall be constructed of alternate layers of corrugated and flat aluminum sheet material. Both sides of the exchanger shall be completely smooth with less than 0.005" variation between alternate layers to allow for optimum sealing surface for brush seals. The rotor shall have smooth air channels to ensure laminar airflow for low-pressure drops. Dry particles up to 900 microns shall pass freely through the rotor without clogging the media. The rotor media shall be capable of being cleaned with low temperature steam without degrading unit performance. The rotor media must be made of aluminum that is coated to prohibit corrosion. All surfaces shall be coated with a non-migrating absorbent specifically developed for the selective transfer of water vapor.]

Performance shall be as scheduled and verified by manufacturer. Assuming equal sensible and latent recovery effectiveness shall not derive performance.

The rotor housing shall be constructed using a heavy-duty extruded and anodized aluminum tube frame (rotors less than 42" shall have a heavy duty galvanized frame without insulation) with double wall galvanized sheet metal panels with fiberglass insulation. Adjustable brush seals must be provided along the periphery of the rotor and between the inlet and outlet air passages to effectively prevent air leakage and cross-contamination between airflows. Total airflow between air streams from leakage and purge shall be less than 10% at 2.5"w.g. differential pressure between airflows. Rotor and casing shall be reinforced to prevent deflection from differential pressures to less than 0.03 inches. All rotors shall be mounted on sealed permanently lubricated spherical bearings. All rotors over 80" in diameter must have flanged or pillow block bearings that can be serviced or replaced without removal of the rotor from the case.

[The unit must be provided with a factory set, field adjustable purge sector designed to limit cross contamination at qualified appropriate design conditions to less than 0.04 percent of the exhaust air stream concentration. Independent laboratory evaluations must indicate purge sector configurations, rotor construction, gasses, air pressure differentials, rotor speeds and other phenomena that constitute "appropriate design conditions" required to limit crosscontamination and air leakage.]

The rotor drive system shall consist of a self-adjusting belt around the rotor perimeter driven by an AC motor with gear reduction. The variable speed drive shall be specifically designed for heat wheel applications and include: an AC inverter, soft start/stop, rotation detection w/ alarm contacts, automatic self-cleaning jog cycle, and self testing capability. The speed controller shall be capable of accepting a potentiometer, VDC, or mA control signal.

[The temperature control system shall consist of an integral control panel with remote temperature sensors mounted in each of the four air streams to monitor exchanger performance. The control shall modulate rotor speed to (1) prevent frost build-up, (2) reduce heat recovery for economizer mode, and (3) switch to maximum heat recovery when outdoor temperature is higher than indoor temperature. A digital display keypad for monitoring temperatures and changing set points shall be included.]

[Bypass dampers shall be furnished.]

AHRI Certification: Sensible and latent recovery effectiveness must be clearly certified by the energy recovery wheel supplier through AHRI in accordance with AHRI Standard 1060.]

2.12 DAMPERS

- A. Damper Leakage: Leakage rate shall be less than two tenths of one percent leakage at 2 inches static pressure differential. Leakage rate tested in accordance with AMCA Standard 500.

2.13 CONTROLS

- A. [Manufacturer shall furnish and mount 24V control components that shall be terminated at a sealed junction box on the unit exterior of each section in which the component is mounted. The components include low temperature limits (freeze-stats), air proving switches, discharge air, return air, exhaust air temperature sensors, and CO2 sensors as specified in the control schedule. The control components must be compatible with [Alerton] [Automated Logic] [Honeywell] [Invensys] [Johnson Controls] [Siemens] as indicated in the control specification. [The manufacturer shall furnish and mount [Belimo] [Johnson Controls] actuators for all dampers.]

PART 3: EXECUTION

3.01 INSTALLATION

- A. Install in accordance with manufacturer's Installation & Maintenance instructions.

3.02 ENVIRONMENTAL REQUIREMENTS

- A. Do not operate units for any purpose, temporary or permanent, until ductwork is clean, filters are in place, bearings lubricated, and fan has been test run under observation.

3.03 EXTRA MATERIALS



Daikin Applied Training and Development

Now that you have made an investment in modern, efficient Daikin equipment, its care should be a high priority. For training information on all Daikin HVAC products, please visit us at www.DaikinApplied.com and click on Training, or call 540-248-9646 and ask for the Training Department.

Warranty

All Daikin equipment is sold pursuant to its standard terms and conditions of sale, including Limited Product Warranty. Consult your local Daikin Representative for warranty details. To find your local Daikin Representative, go to www.DaikinApplied.com.

Aftermarket Services

To find your local parts office, visit www.DaikinApplied.com or call 800-37PARTS (800-377-2787). To find your local service office, visit www.DaikinApplied.com or call 800-432-1342.

This document contains the most current product information as of this printing. For the most up-to-date product information, please go to www.DaikinApplied.com.

Products manufactured in an ISO Certified Facility.