

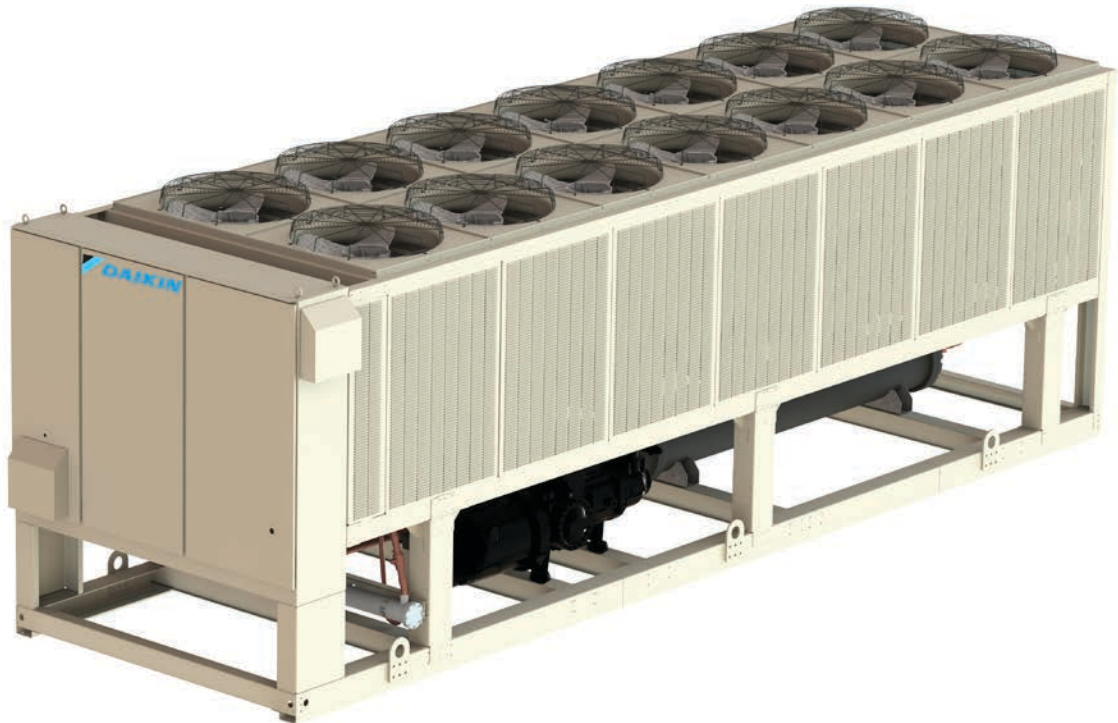

Catalog 626-10

**Pathfinder®
Air Cooled Screw Chillers**

**Model AWW
100 to 565 Tons (350 to 1985 kW)
HFC-134a Refrigerant
60/50 Hz**



Introduction	3	Application Considerations	10
Features and Benefits	4	Unit Placement	10
Infinite Possibilities	4	Restricted Air Flow	10
The Compressor Technology	4	Clearance Requirements	11
The Condenser Technology	4	Chilled Water Systems	11
The Control Technology	5	Optimizing Efficiency	14
Dimensions and Weights	7	Electrical Connections	14
Options and Accessories	8	Integrated Waterside Economizer	16
Unit Options	8	Engineering Guide Specifications	18
Controls Options	9		
Electrical Options	9		

Manufactured in an ISO 9001 & ISO 14001 certified facility



©2022 Daikin Applied. Illustrations and data cover the Daikin Applied product at the time of publication and we reserve the right to make changes in design and construction at any time without notice.

Trailblazer® Air-Cooled Scroll Chiller
Model AMZ • 10 - 40 RT

Trailblazer® Air-Cooled Scroll Compressor Chiller
Model AGZ-E • 30 - 241 RT
Variable Speed Condenser Fan Technology with Remote Evaporator, Heat Recovery and High-Efficiency options available

Pathfinder® Air-Cooled Screw Compressor Chiller
Model AWW VFD • 100 - 565 RT
100% Configurable with Variable Volume Ratio (VVR) Technology Remote Evaporator and Integrated Water-side Economizer options available

SITELINE™
DAIKIN BUILDING CONTROLS

cp
2021 AWARD WINNER

Technology Designed for Flexibility

Daikin Pathfinder® air-cooled chillers continue to redefine what it means to be “industry leading.” The latest evolution of Pathfinder® chillers offers the highest energy efficiency levels available. Daikin Applied utilizes proven technologies in a newly engineered and flexible design to achieve world-class efficiency performance and low noise within a compact footprint.

- Fully configurable unit architecture and options
- State of the art variable volume ratio compressor design optimizes efficiency at all operating conditions
- Integrated compressor variable frequency drive (VFD)
- User-friendly MicroTech® controls
- RapidRestore® and Fast Loading for mission critical applications
- Open Choices™ feature for BAS of your choice
- Integrated waterside economizer option to satisfy 100% of cooling load using no compressor energy
- Remote evaporator option keeps the evaporator indoors, eliminating glycol from the water loop in colder regions.
- Factory testing for trouble free startup and reliable operation
- HFC-134a refrigerant
(Zero ozone depletion and no refrigerant phase out date)
- AHRI certification

Features and Benefits Summary

Infinite Possibilities

Fully configurable unit architecture provides the capacity, efficiency, and sound requirements to fit the needs of each individual customer for the lowest total cost of ownership.

The Compressor Technology

Unique compressor design with variable volume ratio capability and integrated VFD for exactly matching required cooling at the best possible efficiency. The single rotor design and built-in muffler lead to quiet operation at all load conditions.

The Control Technology

Smart controls seamlessly tie together the flexible unit configuration concept. Proactive control logic with RapidRestore® and Fast Loading capabilities keep units running under extreme operating conditions when needed most.

Certifications and Standards

Meets ASHRAE Std. 90.1, AHRI 550/590 certified, and contributes to LEED® certification.

Infinite Possibilities

Fully configurable unit to exactly meet customer design requirements for energy efficiency, performance, acoustics and space. The major configurable components are:

- Daikin designed compressor technology for higher energy efficiency and lower sound levels with an integrated VFD.
- Fan design options that further reduce ambient noise while increasing unit efficiency.
- Engineered, flexible unit design to accommodate a vast array of component sizes to maximize capacity within the smallest possible footprint.
- Application flexibility with integrated waterside economizer and remote installed evaporator options available. Technical details for options can be found in the installation manual, available at www.DaikinApplied.com.

The Compressor Technology

Chiller performance is optimized at every condition and at every hour of the day with unique VVR® (variable volume ratio) compressor technology and patented high-efficiency oil separation. The compressor adjusts compression volumetric ratio to meet the demands of the building or process at that moment to maximize efficiency. While performance is matched in real-time as conditions vary, built-in and patented compressor mechanics reduce noise and vibration resulting in neighborhood friendly sound levels at all load points.

Figure 1: VVR® Compressor Technology

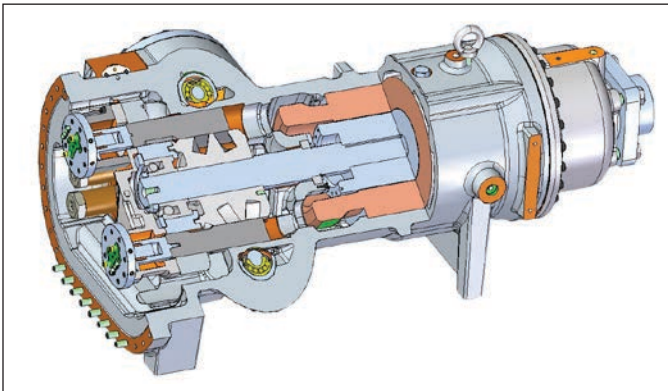

Integrated Variable Frequency Drive

A Variable Frequency Drive (VFD) is integral to the Pathfinder model AWV chiller design by modulating compressor speed in response to load and evaporator/condenser pressure. By applying a VFD to all screw compressor motors, significant gains in compressor part load efficiency are realized by reducing motor speed in conjunction with reduced cooling requirements.

The improvements in efficiency and annual energy costs are maximized when there are long periods of part-load operation and lower ambient temperatures. Based on AHRI Standard 550/590, chillers will typically run 99% of the time at part load conditions so energy savings will be seen in almost every application.

Pathfinder® chillers with VFDs provide a high power factor rating without the use of capacitors.

The Condenser Technology

Condenser coils are all 9153 aluminum alloy microchannel design with a series of flat tubes containing multiple, parallel flow microchannels layered between the refrigerant manifold piping. Aluminum alloy 9153 offers higher resistance to corrosion than other alloys such as 3102 alloy. Compared to traditional copper and aluminum coil designs, microchannel coils have proven to be:

- environmentally friendly by using significantly less refrigerant
- more energy efficient
- resistant to galvanic corrosion with all aluminum design .



Figure 2: Shrouded Fan Assembly with Molded Blade

Daikin Applied utilizes a unique new fan assembly that features a one-piece, molded blade in a shrouded condenser fan design and low speed operation for ultra high efficiency. The fan moves large volumes of air at exceptionally low sound levels and is immune to rust, broken rivets and other ills possible with conventional fans. The advanced composite material has been tested to withstand UV light, heat, and humidity corrosion in some of the most



severe climates in the world.

Figure 3: DC Fan Motor

As part of the fully configurable Pathfinder model AWV chiller architecture, condenser fan motors can further enhance unit performance by adding 2 different options for variable speed control:

- Option 1 - A variable speed drive on the first fan motor of each circuit combined with control logic to modulate fan speed to provide stable low ambient operation.
- Option 2 - Variable speed ECM/DC permanent magnet fan motors on every condenser fan to ensure an exact response to real time conditions at the lowest power consumption and optimize part load efficiency.



Expanding on the configurability of Pathfinder model AWW chillers, an integrated system of waterside economizer coils is an option to drastically reduce power usage while meeting the cooling requirements at lower ambient temperatures. Depending on the outside temperature, the integrated economizer option may be able to satisfy 100% of cooling load without starting a compressor. The ability for the chiller to choose the most efficient operating mode - mechanical cooling with the VVR® compressor technology or waterside economizers or a combination of both in hybrid mode - can yield the lowest total cost of ownership in many applications.

Figure 4: Integrated Waterside Economizer Operation

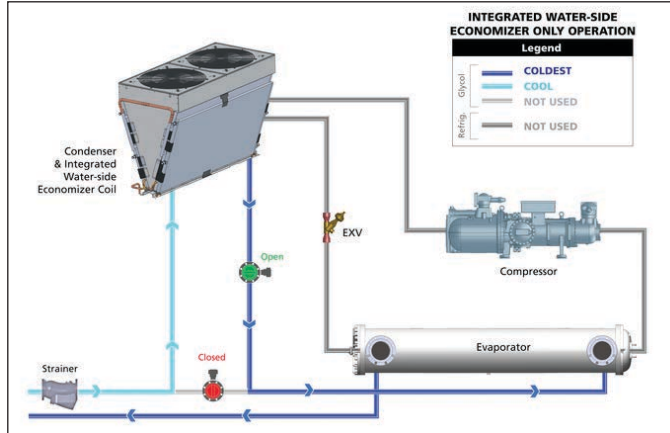

AHRI Certification

Part load performance can be presented in terms of Integrated Part Load Value (IPLV), which is defined by AHRI Standard 550/590. Based on this AHRI Standard, and as shown in Figure 5, a typical chiller can operate up to 99% of the time at off-peak conditions and usually spends most of this time at less than 60% of design capacity.

Figure 5: IPLV Defined by AHRI Standard 550/590

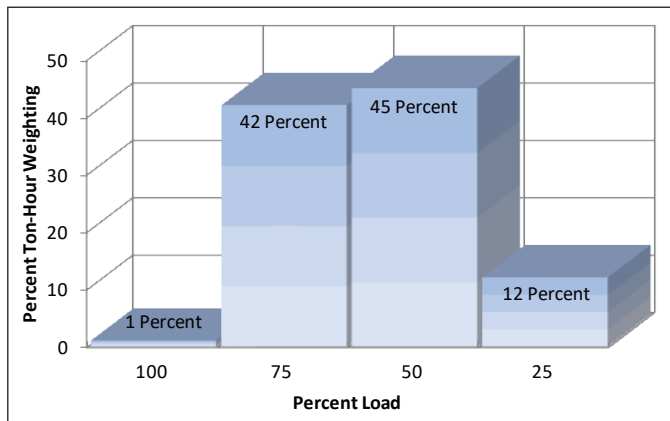

AWV chillers are rated and certified to AHRI Standard 550/590. The ability of AWW chillers to achieve very high part load efficiencies, as evidenced by their world-class IPLV ratings, is due primarily to the use of a variable frequency drive and exact unit configuration to maximize performance.

Compliance with ASHRAE Std. 90.1

ASHRAE Standard 90.1 was developed to help owners and designers make informed choices on building design, systems, and equipment selection. Model AWW can significantly exceed ASHRAE 90.1 minimum efficiency requirements.

LEED®

For building owners who wish to pursue Leadership in Energy and Environmental Design (LEED®) Green Building Certification, the performance of the WWV may contribute points towards Energy and Atmosphere (EA) Credits.

Points earned for Optimize Energy Performance (formerly EA Credit 1) are awarded based on overall building efficiency. The high efficiency of the AWW will contribute to the total points earned for this credit. Enhanced Refrigerant Management (formerly EA Credit 4) qualification is partially determined by tonnage and refrigerant quantity. Unit configurations will affect the quantity of refrigerant in the chiller.

Consult with your Daikin Applied sales representative for more information.

The Control Technology

The MicroTech® III unit controller provides an easy to use control environment. The control logic is designed to provide maximum efficiency, to continue operating during extreme, unexpected conditions and to give a history of unit operation.

RapidRestore®

Mission critical facilities such as data centers and hospitals are demanding stringent capabilities for chillers to restart and reach full load operation quickly in the event of a power loss. With the capability of RapidRestore®, Pathfinder® model AWW chillers are engineered to meet those needs. AWW chillers can reach full load operation in less than 5 minutes after power restoration for specific configurations.

RapidRestore® – Quickly restores cooling capacity when power returns after a power failure

- **Compressor Start** – Amount of time required for the chiller to restart
- **Fast Loading** – Amount of time required for the chiller to reach a certain load condition

Table 1: RapidRestore® Times - After Power Restoration

First Compressor Start	Fast Loading to 100% Load
35 sec	Less than 5 min

* Estimated load time. Actual times depend on operating conditions and unit configuration.



SiteLine™ Building Controls

Daikin makes building automation simpler, more effective and easier to scale than any other controls solution on the market today.

Whether you're overseeing a complex HVAC ecosystem of equipment and buildings or monitoring standalone units, SiteLine Building Controls and Service Solutions will help you create comfortable and sustainable environments where tenants work and live.

Daikin's scalable, cloud-based building automation systems (BAS) instantly and easily optimize the performance of any HVAC ecosystem—including other makes and existing building systems. Plus, our real-time analytics provide effortless insight and enable optimization for energy, indoor air quality (IAQ) and sustainability.

Benefits

- Easy installation with out-of-the box functionality for both new and retrofit applications.
- Simple operation that brings insight to system performance and is intuitive to manage.
- Low upfront costs that enable you to work with other equipment systems
- Scalable solutions for both standalone equipment and building systems.
- Advanced security that protects customer data.

Open Choices™ BAS Flexibility

The exclusive Open Choices™ feature provides seamless integration and comprehensive monitoring, control, and two-way data exchange using industry standard protocols such as LonTalk®, BACnet® or Modbus®. Open Choices™ offers flexibility to use the Building Automation System (BAS) of your choice without an expensive gateway panel. Open Choices™ benefits include:

- Easy to integrate into your BAS of choice
- Factory- or field-installed communications module
- Integrated control logic for factory options
- Easy-to-use local user interface
- Comprehensive data exchange

Factory Testing

All Daikin Applied air-cooled chillers (50 or 60 hertz) are factory-tested prior to shipment. Operating and safety controls are checked for correct settings and operation. This testing helps reduce field start-up issues and maintain critical construction schedules.



More information about SiteLine™ is available at www.DaikinApplied.com.

Unit Dimensions and Weights

Figure 6: Unit Illustration for Dimensions

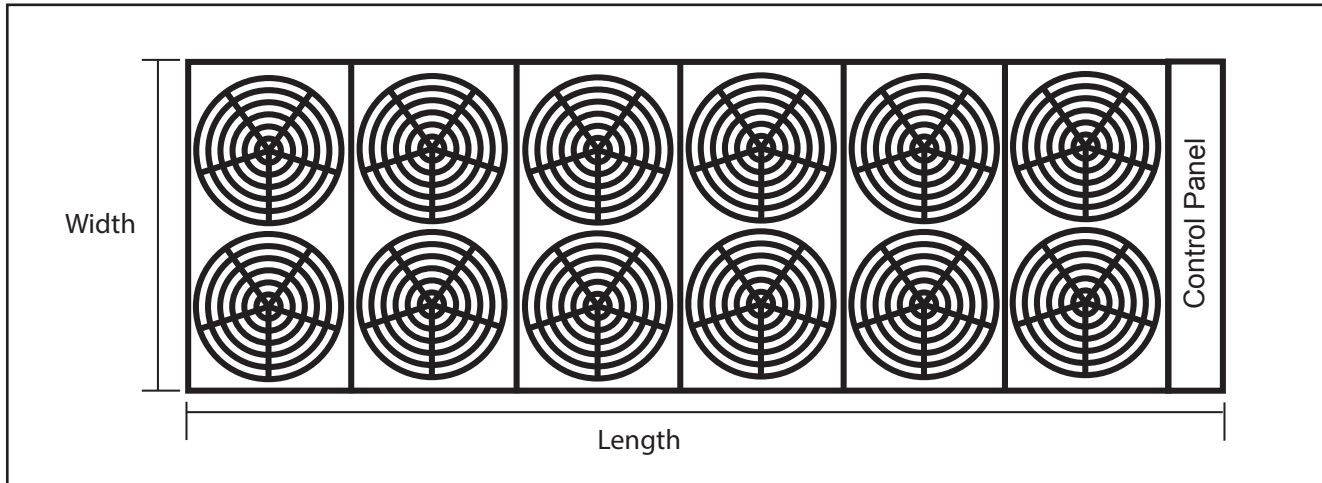

Table 2: Dimensions and Shipping Weights

Number of Fans	Length	Width	Height	Shipping Weight	Operating Weight	Additional Weights - lb (kg)	
	in (mm)	in (mm)	in (mm)	lb (kg)	lb (kg)	Sound Enclosures	Grilles/ Louver Panels
8	179.3 (4,554)	88.0 (2,235)	100.1 (2,543)	10,814 (4,905)	10,983 (4,982)	614 (279)	617 (280)
10	217.2 (5,517)			12,251 (5,557)	12,520 (5,679)		726 (329)
12	258.1 (6,556)			13,775 (6,248)	14,336 (6,503)		860 (390)
14	296.0 (7,518)			15,252 (6,918)	16,140 (7,321)	680 (308)	980 (445)
16	334.0 (8,484)			16,290 (7,389)	17,574 (7,971)		1,090 (494)
18	371.7 (9,441)			17,962 (8,147)	19,246 (8,730)		1,215 (551)
20	409.6 (10,404)			19,830 (8,995)	21,750 (9,866)		1,325 (601)
22	447.5 (11,367)			21,002 (9,526)	23,266 (10,553)		1,440 (653)
24	485.4 (12,329)			22,670 (10,283)	24,934 (11,310)		1,560 (708)
26	523.2 (13,289)			24,497 (11,112)	26,761 (12,139)		1,670 (758)
28	561.0 (14,249)			25,239 (11,448)	27,503 (12,475)		1,785 (810)
30	598.9 (15,212)			26,110 (11,843)	28,374 (12,870)		1,895 (860)

Drawing Notes

- Weights shown reflect the largest possible evaporator and control panel box of a packaged unit.
- Minimum clearances are required for unit operation and service. See [page 11](#) for installation requirements.
- 3.0-inch diameter lifting holes are provided. See lifting instructions in the current version of the installation, operation, and maintenance manual, available at www.DaikinApplied.com.
- The unit is shipped with a full operating charge of refrigerant.
- Integrated waterside economizer (IWSE) option changes the operational dimensions of the unit; however, IWSE piping is removable for installation and service - see [Figure 7](#).
- Installation specific drawings are available from a Daikin Applied sales representative.

Figure 7: Representative IWSE Image



Unit Options

Integrated Waterside Economizer

The integrated waterside economizer option adds fluid-to-air heat exchanger coils in series with the airflow of the primary chiller condenser coils in order to reject heat to the outdoor air without the need for vapor compression cooling. This type of cooling is possible when the outdoor air temperature is colder than cooling fluid temperature requirements.

Low Ambient Operation

Factory mounting of a variable frequency drive (VFD) motor on the lead condenser fan motor for each circuit or ECM/DC fan motors on all condenser fans allow chillers to start down to an ambient of -10°F (-23.3°C) and operate as low as -20°F (-28.9°C).

Baked Epoxy Condenser Fin Coating

Epoxy coated coils have a flexible dip and baked epoxy protective coating with 10,000+ hour salt spray resistance (ASTM B117-90). The coating is available on the microchannel condenser coils. Provides protection against adverse environments such as salt air as found on seacoast applications and many chemical environments. Consult the local Daikin Applied sales office for complete specification and chemical resistance chart.

Protective Coil Guards

Optional factory installed wire mesh upper coil guards provide protection against coil damage from debris.

Protective Base Guards

Optional factory installed wire mesh lower base guards provide protection for ground level installations.

Louvers (Wind and Hail Protection)

Coil-Only Louvers

Coil louvers are available as a factory-installed (or as a field-installed kit) option. This option can help increase the saturated condensing temperature in cold, windy conditions, allowing it to operate at lower ambient temperatures. This option also protects the condenser from hail damage.

Figure 8: Coil-Only Louvers

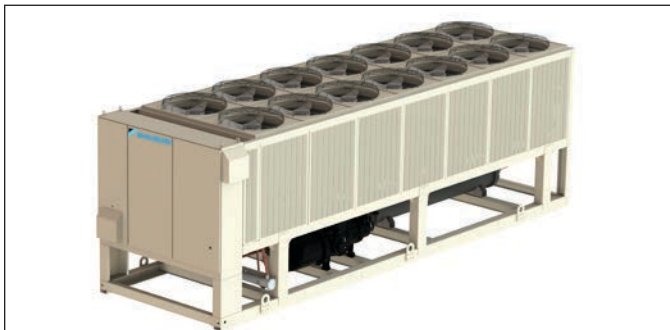

Coil and Base Louvers

The coil louvers can also be supplied with base louvers, which when combined, enclose the entire side and end of the unit. The base louvers are primarily for limiting access to only authorized personnel as well as enhancing unit appearance. This option is available as a field-installed kit.

Wind Load Rated

AWV models have been evaluated to withstand up to 181 mph winds when ordered with this option, which is available on most sizes. Contact your local Daikin Applied sales representative with your specific installation and wind pressure requirements.

Vibration Isolators

Spring or rubber-in-shear vibration isolators are available for field installation under the unit base frame on sound sensitive applications.

Sound Attenuation

The model AWV chiller includes low noise construction as standard. Should additional sound attenuation be required, there are factory installed sound reduction options available.

Suction Shutoff Valves

Factory-mounted suction shutoff valves that, when used in conjunction with the optional compressor discharge valves, isolate compressors for service.

Liquid Line Solenoid Valve

Factory-mounted liquid line solenoid valve acts in conjunction with the electronic expansion valve for liquid shutoff to the evaporator.

Remote Evaporator

Models with optional remote evaporator will have the evaporator shipped separately for field installation, piping, and wiring to the outdoor unit.

Right-hand Evaporator Connections

Right-hand evaporator water connections (as viewed from the control panel) are an available option.

Evaporator Inlet Strainer

Evaporator inlet water strainer kit consisting of Y-type strainer with 304 stainless steel perforated basket, blowdown valve, matching pipe extension with two Schrader fittings and two Victaulic couplings for field installation. Details on [page 12](#).

Double Evaporator Insulation

Double evaporator thermal insulation is available and recommended for low fluid temperature applications.

Controls Options

Flow Switch

A flow switch is necessary to avoid evaporator freeze-up under low or no flow conditions. A thermal dispersion flow switch located in the evaporator outlet nozzle is factory installed and wired as standard (packaged models) or shipped along with the unit for field installation (remote evaporator models). Terminals are provided in the unit control center for field connection of the water flow switch.

BAS Modules

A factory-installed communication module allows communications with BAS standard protocols such as BACnet® w/ MSTP, BACnet® w/ Ethernet, LonMark® or Modbus®. The module can also be retrofitted after shipment.

SiteLine™ Building Controls

SiteLine from Daikin Applied is a secure, scalable, cloud-based controls solution that can optimize the performance of equipment and building systems. SiteLine provides real-time analytics for energy management, indoor air quality (IAQ) and sustainability. BAS installation is easy with out-of-the box functionality for both new and retrofit applications

Door Mounted User Display

The control panel display is mounted on the door with a cover for weather protection. Information is easily accessible through the clear cover that can be secured for additional unit security.

Figure 9: Covered Door Mounted Display



Remote User Interface

A remote control panel that mimics operation of the controller located on the unit. Up to eight Pathfinder® units can be connected to it and selected on the screen. It provides HMI (Human Machine Interface) within a building, without going outdoors to the unit. The remote interface is shipped with the unit for field installation. The remote panel is powered from the unit and no additional power supply is required.

Electrical Options

RapidRestore® and Fast Loading

Data center and other critical installations often require a fast return to 100% cooling load after a power interruption. RapidRestore® provides a 35 -second restart capability and fast compressor loading. More information is available at www.DaikinApplied.com.

Power Connections

The standard power connection is single-point to a factory-mounted, molded case, disconnect switch. Each circuit is factory-wired from the disconnect switch to an isolating circuit breaker for each compressor circuit. See [page 14](#) for ratings of standard and optional electrical panels.

Single-Point Power with HSCCR Panel

High short-circuit current rated panel includes high interrupting capacity unit disconnect switch and factory-wiring to standard isolating circuit breakers for each circuit. The high short circuit rated panel means that a short circuit current up to the ratings shown on [page 14](#) will be contained within the panel enclosure.

Single-Point Connection to Power Block

Single -point connection to a power block with isolating circuit breakers for each circuit.

Multi-Point Power with Disconnect Switch

Multiple power supply to disconnect switches with through-the-door handles and no individual branch circuit breakers.

Multi-Point Power with HSCCR Panel

High short-circuit current rated panel. Includes two high interrupting capacity disconnect switches. Isolating circuit breakers for each compressor are not included. The high short circuit rated panel means that a short circuit current up to the ratings shown on [page 14](#) will be contained within the panel enclosure.

Ground Fault Protection

Provides ground fault protection for the entire unit.

115V Convenience Outlet

Outlet mounted in unit electrical panel.

Table 3: Operating Limits

Maximum standby ambient temperature NOTE: Maximum operating ambient temperature is determined by unit configuration	130°F (54.4°C)
Minimum operating ambient temperature - standard ambient control	32°F (0°C)
Minimum starting ambient temperature - low ambient control option	-10°F (-23.3°C)
Minimum operating ambient temperature - low ambient control & integrated waterside economizer options	-20°F (-28.9°C)
Leaving chilled water temperature	40°F to 70°F (4.4°C to 21.1°C)
Leaving chilled fluid temperatures (with anti-freeze) - NOTE: Unloading is not permitted with fluid leaving temperatures below 25°F (-3.9°C).	17°F to 70°F (-8.3°C to 21.1°C)
Operating chilled water delta-T range	6°F to 20°F (3.3°C to 11.1°C)
Maximum evaporator operating inlet fluid temperature	88°F (31.1°C)
Maximum evaporator non-operating inlet fluid temperature	100°F (38°C)

Unit Placement

For roof-mounted applications, the unit must be installed on a steel channel or I-beam frame to support the unit above the roof. Vibration isolators are recommended for all roof-mounted installations or wherever vibration transmission is a consideration. Isolator loads and kit numbers can be found in the current installation and operation manual at www.DaikinApplied.com.

For ground level applications, the unit must be installed on a substantial base that will not settle. Daikin Applied recommends a one-piece concrete slab with footings extended below the frost line, and the installation engineer should determine its necessity. The foundation must be level within 13 mm (1/2 inch) over its length and width and strong enough to support the unit's operating weight as listed in the Physical Data tables. The addition of neoprene waffle pads (supplied by customer) under the frame allows water to drain from inside the frame, which can act as a dam.

On ground level applications, protection against vandalism is recommended; either by the optional factory-installed lower wire mesh guards or louvers, or by a field installed screening fence. Note that the fence must allow free flow of air to the condenser coil for proper unit operation. Upper wire mesh coil guards are standard.

Restricted Air Flow

The clearances required for design operation of Pathfinder® air-cooled chillers are described in Figure 11. Occasionally, these clearances cannot be maintained due to site restrictions such as units being too close together or a fence or wall restricting airflow, or both. Pathfinder® chillers have several features that may help mitigate the penalties attributable to restricted airflow.

The MicroTech® III control is proactive in response to “off-design conditions”. In the case of single or compounded influences restricting airflow to the unit, the microprocessor will act to keep the unit running (at reduced capacity), rather than allowing a shut-off on high discharge pressure.

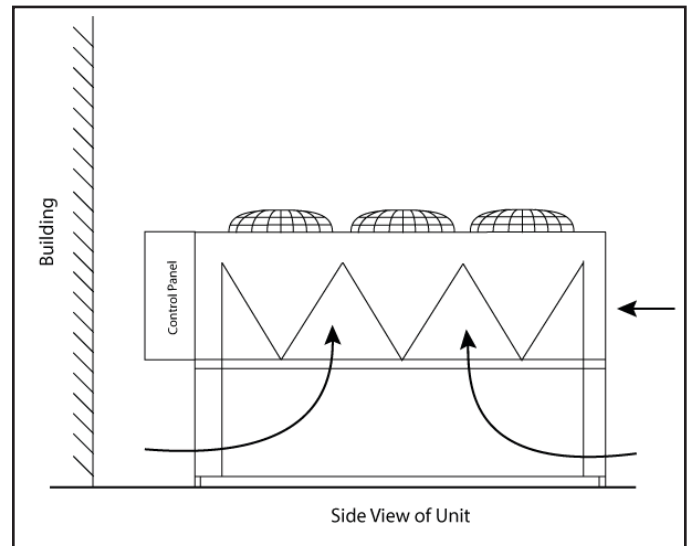
Figure 10: Representative Air Flow

Clearance Requirements

Figure 11: Spacing Guidelines

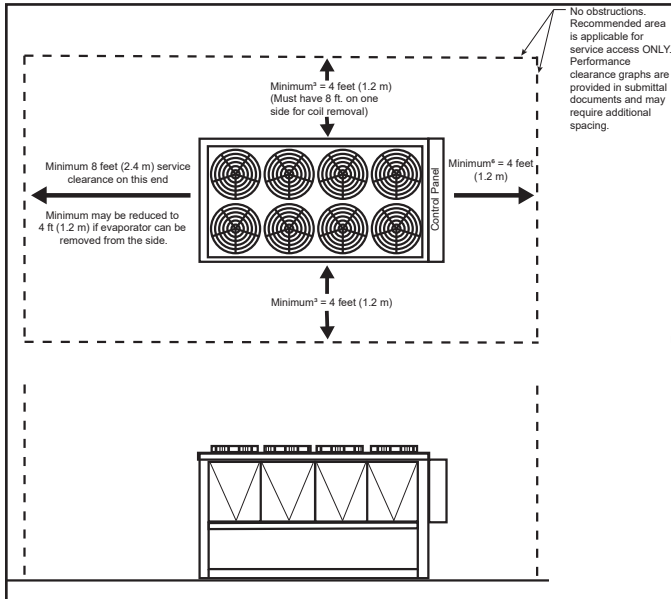

- NOTE:**
1. There should be no obstruction above the fan deck to interfere with fan discharge.
 2. Electrical conduit and field installed electrical devices should not block service access to any chiller components.
 3. Integrated Waterside Economizer (IWSE) units need a minimum side clearance of 5 ft (1.5 m) as measured from the outer base rail of the unit.
 4. Such factors as prevailing winds, additional equipment within the space, design outdoor air temperature, and numerous other factors may require more clearance than what is shown.

Sufficient clearance must be maintained between the unit and adjacent walls or other units to allow the required unit air flow to reach the coils. Failure to do so will result in a capacity reduction and an increase in power consumption. No obstructions are allowed above the unit at any height.

The current version of the Pathfinder® Model AWW installation, operation and maintenance manual for packaged units gives the minimum clearance for different types of installations and also capacity reduction and power increase adjustments if closer spacing is used.

Chilled Water Systems

Water Piping

Start-up procedures should confirm that the chilled water piping system had been properly flushed out before being connected to the chiller vessel. Be sure water inlet and outlet connections match certified drawings and nozzle markings. All evaporators have OGS-type grooved water connections (adhering to Standard AWWA C606) or optional flange connections. PVC piping should not be used.

CAUTION

To prevent damage to the evaporator and potential chiller failure, a supply strainer is required in the inlet water piping which connects to this evaporator. This strainer must be installed prior to operation of the chilled liquid pumps.

Field installed water piping to the chiller **must** include:

- A cleanable strainer installed at the water inlet to the evaporator to remove debris and impurities before they reach the evaporator, causing damage. See the Inlet Strainer Guidelines on [page 12](#) and the current version of the product installation, operation and maintenance manual on www.DaikinApplied.com for additional details.
- A water flow switch must be installed in the horizontal piping of the supply (evaporator outlet) water line to avoid evaporator freeze-up under low or no flow conditions. A flow switch proves that there is adequate water flow to the evaporator before the unit can start or to shut down the unit if water flow is interrupted. See [page 9](#) for more information.
- Purge air from the water system before unit start-up to provide adequate flow through the evaporator with an air vent located at the piping system high point. An air vent is also located at the top of each water head of the evaporator. Each evaporator water head is also provided with a drain connection.
- Adequate piping support, independent from the unit, to eliminate weight and strain on the fittings and connections.

It is **recommended** that the field installed water piping to the chiller include:

- Thermometers at the inlet and outlet connections of the evaporator.
- Water pressure gauge connection taps and gauges at the inlet and outlet connections of the evaporator for measuring water pressure drop.
- An expansion tank or regulating valve to maintain adequate water pressure.
- Vibration eliminators in both the supply and return water lines to reduce transmissions to the building.
- Regular water analysis and chemical water treatment for the evaporator loop is recommended immediately at equipment start-up.

Figure 12: Typical Chilled Water Piping, Braze Plate

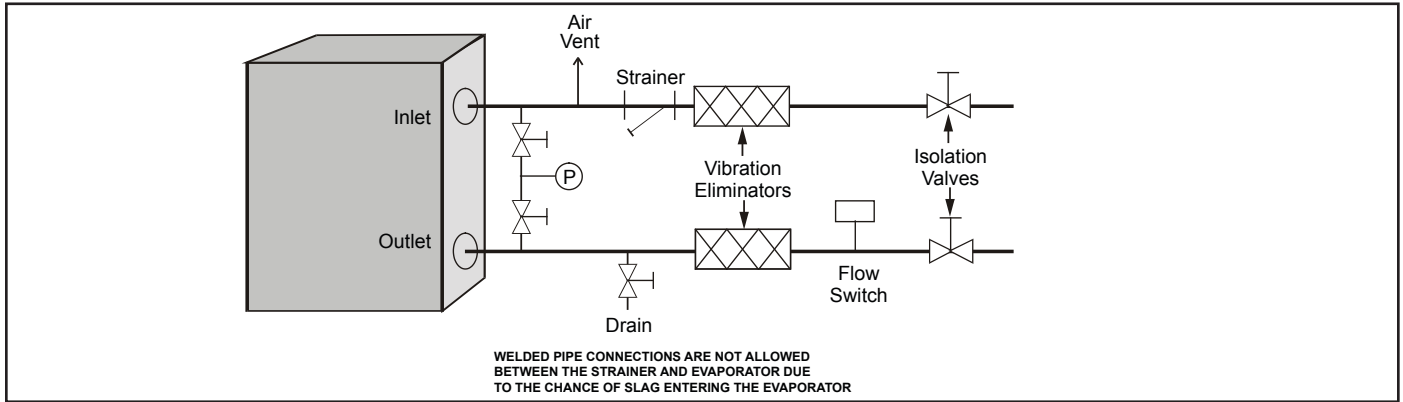
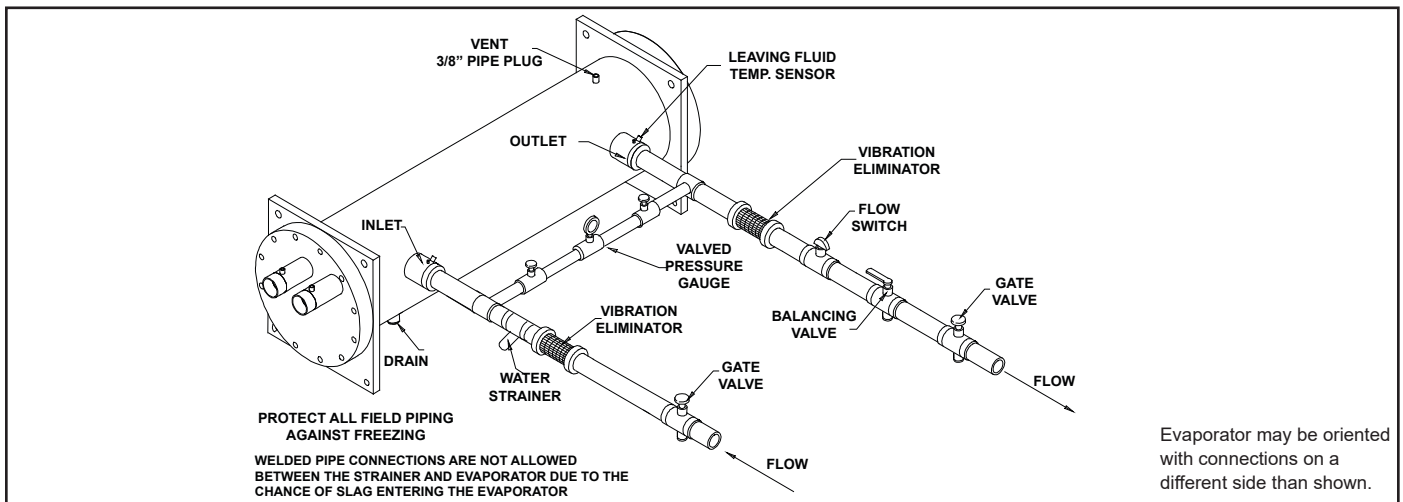

Figure 13: Typical Chilled Water Piping, Shell and Tube



Inlet Strainer Guidelines

An inlet water strainer kit must be installed in the chilled water piping before the evaporator inlet. Two paths are available to meet this requirement:

1. Field-installed kit shipped-loose with the unit consisting:
 - Y-type area strainer with 304 stainless steel perforated basket, Victaulic pipe connections and strainer cap
 - a strainer with perforations no larger than 0.031" (1/32", 0.8 mm) diameter for AWW models with the IWSE option
 - a strainer with perforations no larger than 0.063" (1/16", 1.6 mm) diameter for braze plate evaporators
 - a strainer with perforations no larger than 0.125" (1/8", 3.2 mm) diameter for shell and tube evaporators
 - Extension pipe with two couplings that may be used for gauges and sensors. The pipe provides sufficient clearance from the evaporator for strainer basket removal.
 - 1/2-inch blowdown valve
 - Two grooved clamps

Connection sizes are listed on installation specific drawings available from a Daikin Applied sales representative.

2. A field-supplied strainer that meets specification and installation requirements of the current product installation, operation and maintenance manual on www.DaikinApplied.com.

Water Volume

All chilled water systems need adequate time to recognize a load change to avoid short cycling of the compressors or loss of control. The potential for short cycling usually exists when the building load falls below the minimum chiller plant capacity or on close-coupled systems with very small water volumes.

Design considerations for water volume are the minimum cooling load, the minimum chiller plant capacity during the low load period and the desired cycle time for the compressors.

Assuming that there are no sudden load changes and that the chiller plant has reasonable turndown, a rule of thumb of “gallons of water volume equal to two to three times the chilled water gpm flow rate” is often used.

A properly designed storage tank should be added if the system components do not provide sufficient water volume.

Variable Flow Rates

Many chiller system control and energy optimization strategies require significant changes in evaporator water flow rates. The Pathfinder® AWV chiller line is well suited to take full advantage of these energy saving opportunities using different combinations of shell sizes, number of tubes, and baffle arrangements.

Both excessively high and excessively low fluid flow rates should be avoided. Excessively high fluid flow rates will result in high fluid pressure drops, high pumping power, and potentially tube erosion or damage. Excessively low fluid flow rates should also be avoided as they will result in poor heat transfer, high compressor power, and sedimentation.

Reducing Evaporator Fluid Flow

Several chiller plant control practices — including variable primary flow systems — advocate reducing the evaporator fluid flow rate as the chiller capacity is reduced. This practice can significantly reduce the evaporator pumping power while having little effect on chiller energy consumption. The Pathfinder® AWV chillers are ideal for application in variable evaporator flow systems as long as the published flow limits are taken into consideration when selecting the chiller. If it is decided to vary the evaporator water flow rate, the rate of change should not exceed the minimum or maximum velocity limits. Additionally, the rate of change should not exceed 10% of the design flow per minute. For example, if the maximum design flow is 200 gpm and it will be reduced to a flow of 140 gpm, the change in flow is 60 gpm. Ten percent of 200 gpm equals 20 gpm change per minute, or a minimum of three minutes to go from maximum to desired flow.

Chilled Water Pump

It is important that the chilled water pumps be wired to, and controlled by, the chiller controller. The controller has the capability to selectively send the signal to a pump relay (by others) to start pump A or B or automatically alternate pump selection and also has standby operation capability. The controller will energize the pump whenever at least one circuit on the chiller is enabled to run, whether there is a call for cooling or not. This helps ensure proper unit start-up sequence. The pump will also be turned on when the water temperature goes below the Freeze Setpoint for longer than a specified time to help prevent evaporator freeze-up.

CAUTION

Adding glycol or draining the system is the recommended method of freeze protection. If the chiller does not have the ability to control the pumps and the water system is not drained in temperatures below freezing, catastrophic evaporator failure may occur.

Failure to allow pump control by the chiller may cause the following problems:

1. If any device other than the chiller attempts to start the chiller without first starting the pump, the chiller will lock out on the No Flow alarm and require manual reset.
2. If the evaporator water temperature drops below the “Freeze setpoint” the chiller will attempt to start the water pumps to avoid evaporator freeze. If the chiller does not have the ability to start the pumps, the chiller will alarm due to lack of water flow.
3. If the chiller does not have the ability to control the pumps and the water system is not to be drained in temperatures below freezing, the chiller may be subject to catastrophic evaporator failure due to freezing. The freeze rating of the evaporator is based on the immersion heater and pump operation. The immersion heater itself may not be able to properly protect the evaporator from freezing without circulation of water.

Evaporator Freeze Protection

Evaporator freeze-up can be a concern in the application of air-cooled water chillers in areas experiencing below freezing temperatures. To protect against freeze-up, insulation and an electric heater are furnished with the evaporator. This helps protect the evaporator down to -20°F (-29°C) ambient air temperature. Although the evaporator is equipped with freeze protection, it does not protect water piping external to the unit or the evaporator itself if there is a power failure or heater burnout, or if the chiller is unable to control the chilled water pumps. Use one of the following recommendations for additional protection:

- If the unit will not be operated during the winter, drain evaporator and chilled water piping and flush with glycol. Drain and vent connections are provided on the evaporator for this purpose.
- Add a year-round glycol solution to the chilled water system to provide freeze protection. Freeze point should be approximately 10°F (5.6°C) below minimum design ambient temperature or 10°F below the lowest design leaving water temperature, whichever is lower. The use of glycol anti-freeze is generally considered the safest protection against freeze-up, however, it will reduce the performance of the unit, depending the concentration. Take this into consideration during initial system design and selection. On glycol applications, a minimum fluid concentration should be based on Burst Protection limits.
- The field addition of thermostatically controlled heat tracing and insulation to exposed piping. (Dependent on power availability)

- Continuous circulation of water through the chilled water piping and evaporator. (Dependent on power availability).
- The evaporator immersion heater is factory wired to the 115-volt circuit in the control box. This power can be supplied from a separate source, or it can be supplied from the control circuit. Operation of the heater cable is automatic through the fluid sensing thermostat that energizes the evaporator heater cable for protection against freeze-up. Unless the evaporator is drained in the winter, the disconnect switch to the evaporator heater must be closed. Conversely, do not apply heat to the evaporator if it is drained.

Remote Evaporator Models

For enhanced application flexibility, Pathfinder® chillers are also available with a remote evaporator option. **IF** the mechanical room where the remote evaporator is installed is subject to ambient temperatures below 32°F, wire the heater to the outdoor unit panel and use at least one of the following procedures:

1. Add a concentration of a glycol anti-freeze with a freeze point 10°F below the lowest expected temperature. This will result in decreased capacity and increased pressure drop. Do not use automotive grade antifreezes as they contain inhibitors harmful to chilled water systems. Use only glycols specifically designated for use in building cooling systems.
2. Drain the water from outdoor equipment and piping and blow the chiller tubes dry from the chiller. Do not energize the chiller heater when water is drained from the vessel.

The immersion heater itself may not be able to properly protect the evaporator from freezing without circulation of water, and it is important that the chilled water pumps are wired to, and controlled by, the chiller's controller.

NOTE: The control power can be rewired in the field to a separate 115V supply (do not wire directly to the heater). See the field wiring diagram in the packaged unit IOM (Installation, Operation, and Maintenance manual), available at www.DaikinApplied.com. If this is done, it should power the entire control circuit. Mark the disconnect switch clearly to avoid accidental deactivation of the heater during freezing temperatures. Exposed chilled water piping also requires protection. If the evaporator is drained for winter freeze protection, the heaters must be de-energized to prevent heater burnout.

Ice Mode

Ice making chillers will run very cold fluid during off hours when energy is least expensive to build a tank of ice. The stored ice melts during peak electrical hours to provide as much cooling as possible but there is often a window on warmer days where the chiller will also run to meet the cooling load.

Optional double evaporator insulation is recommended for ice mode operation. The standard controller software will require "ice" setpoint changes and a digital signal into the controller is required to change to the ice mode and back to standard cooling. In ice building mode, the unit will operate at full load until the shutoff temperature setpoint is reached.

Optimizing Efficiency

The optimum plant design must take into account all of the interactions between chillers and pumps. The Daikin Energy Analyzer™ II program is an excellent tool to investigate the entire system efficiency, quickly and accurately. It is especially good at comparing different system types and operating parameters. Contact your local Daikin Applied sales office for assistance on your particular application.

Electrical Connections

All wiring must be done in accordance with applicable local and national codes. Power wiring connections to the chiller may be done with either copper or aluminum selected conductors. Wire sizing and wire count must fit in the power connection lug sizing shown in the unit submittals. Pathfinder® units can be ordered with either standard multi-point power or optional single point power connections and with various disconnect and circuit breaker options.

Wiring within the unit is sized in accordance with the U.S.A. National Electrical Code. Field-supplied disconnect switches are required if not factory-supplied with the unit. Disconnecting means are addressed by Article 440 of the U.S.A. National Electrical Code (NEC), which requires "disconnecting means capable of disconnecting air conditioning and refrigerating equipment including motor-compressors, and controllers from the circuit feeder."

Terminals are provided in a unit control panel for optional field hookup of the control circuit to a separate fused 115-volt power supply in lieu of the standard factory installed control transformer.

Control panels are rated for the amount of current that can be passed through during a short circuit event and still contain any damage within the enclosure; this value is known as the short circuit current rating as shown in [Table 4](#). This option may be required to meet electrical code. Consult with a licensed electrical engineer to determine if your electrical system will require this rating.

Table 4: Short Circuit Current Ratings (kAmps)

Voltage/Hz	Standard Short Circuit Panel Rating	High Short Circuit Panel Rating
380/60	10kA	65kA
460/60	10kA	65kA
575/60	5kA	25kA
400/50	10kA	65kA

Figure 14: Refrigeration System Diagram, Braze Plate Evaporator (shown with optional refrigerant-side economizer)

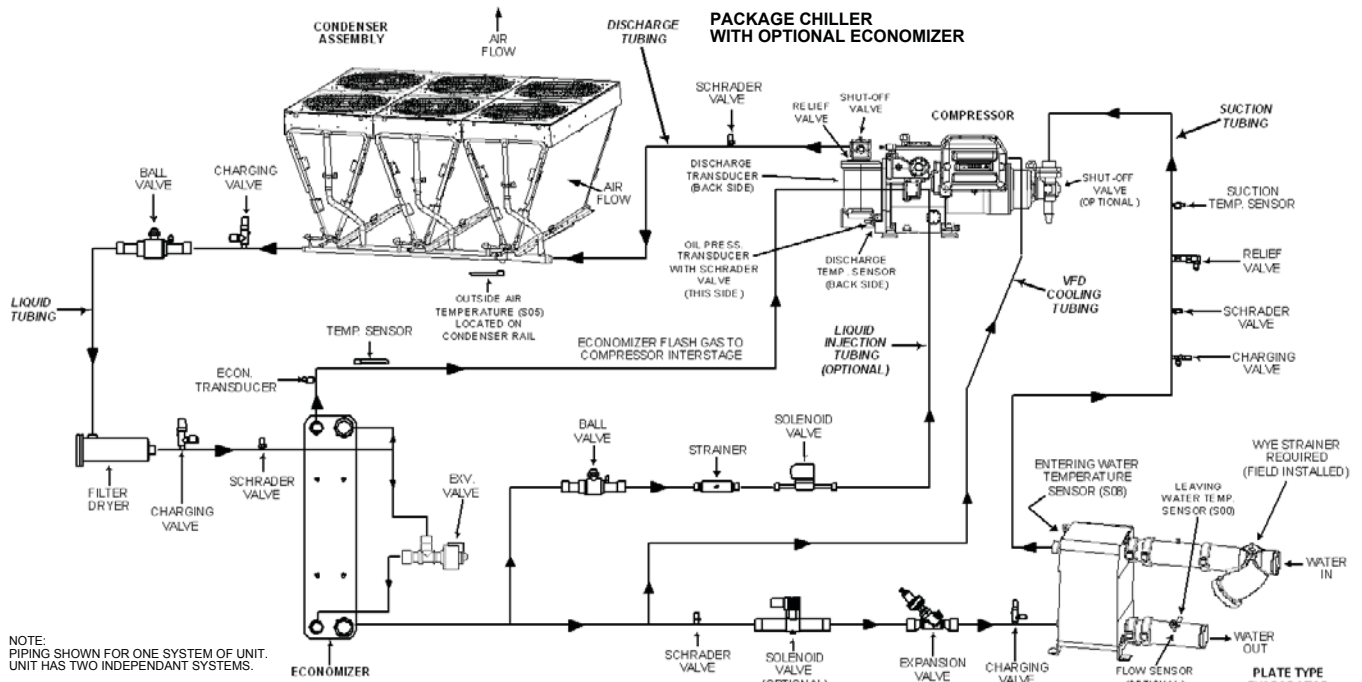

Figure 15: Refrigeration System Diagram, Shell and Tube Evaporator (shown with optional refrigerant-side economizer)

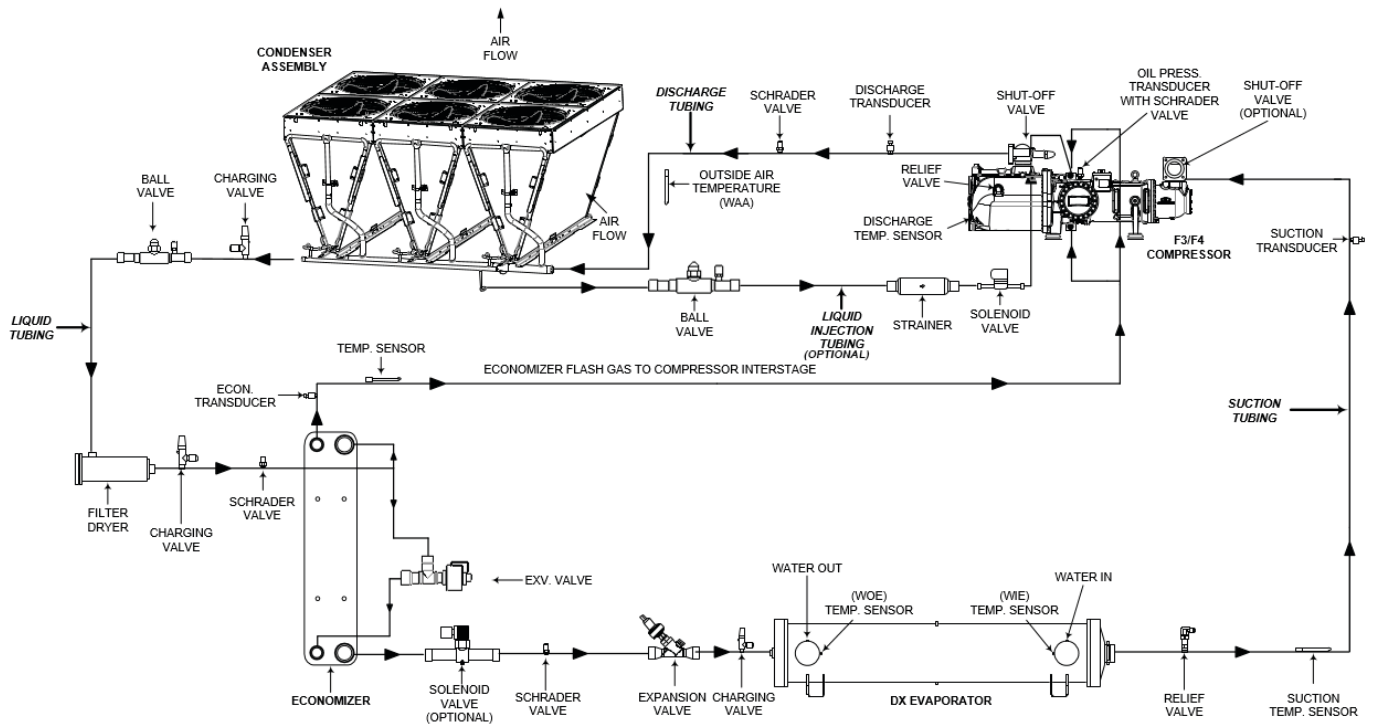

Figure 16: Integrated Waterside Economizer Option - Representative Model



Integrated Waterside Economizer

Pathfinder Model AWW chillers with an integrated system of waterside economizer coils may be able to satisfy 100% of cooling load without starting a compressor. Through a set of valves, the chiller will automatically control where the fluid from the load is directed to achieve optimal system efficiency. Figure 19 illustrates mechanical cooling only mode which would be necessary for high ambient temperatures. Cooling from the integrated waterside economizer (IWSE) coils, Figure 17, is possible when the outdoor air temperature is colder than the fluid temperature requirements.

The unit controller automatically adjusts two 2-way control valves to bring the IWSE coils in or out of the loop. Bypassing the IWSE coils during mechanical operation only mode avoids the additional pressure drop from the economizer coils.

Hybrid cooling mode operation further maximizes the efficiency of the system by rejecting some heat to the IWSE coils before sending the fluid to the evaporator. The mechanical cooling loop will further cool the fluid to the required setpoint but will use much less energy. Figure 17 shows how the two loops work together in hybrid cooling mode.

Waterside Economizer Operating Guidelines

1. Fluid used in IWSE systems must contain glycol.

The system glycol percentage must be high enough to avoid **burst** conditions at the lowest possible ambient temperature of the installed location, regardless of whether the unit is operating or turned off at that minimum temperature. The chiller fluid loop is required to be protected against **burst** conditions at least 5°F below minimum operating and non-operating ambient temperatures. It is recommended to protect the system against **freeze** conditions 5°F below minimum operating and non-operating ambient temperatures. Failure to ensure adequate glycol freeze protection may result in damage of the water-side economizer coils and coolant leakage from the system.

Figure 17: Hybrid Cooling Mode Operation

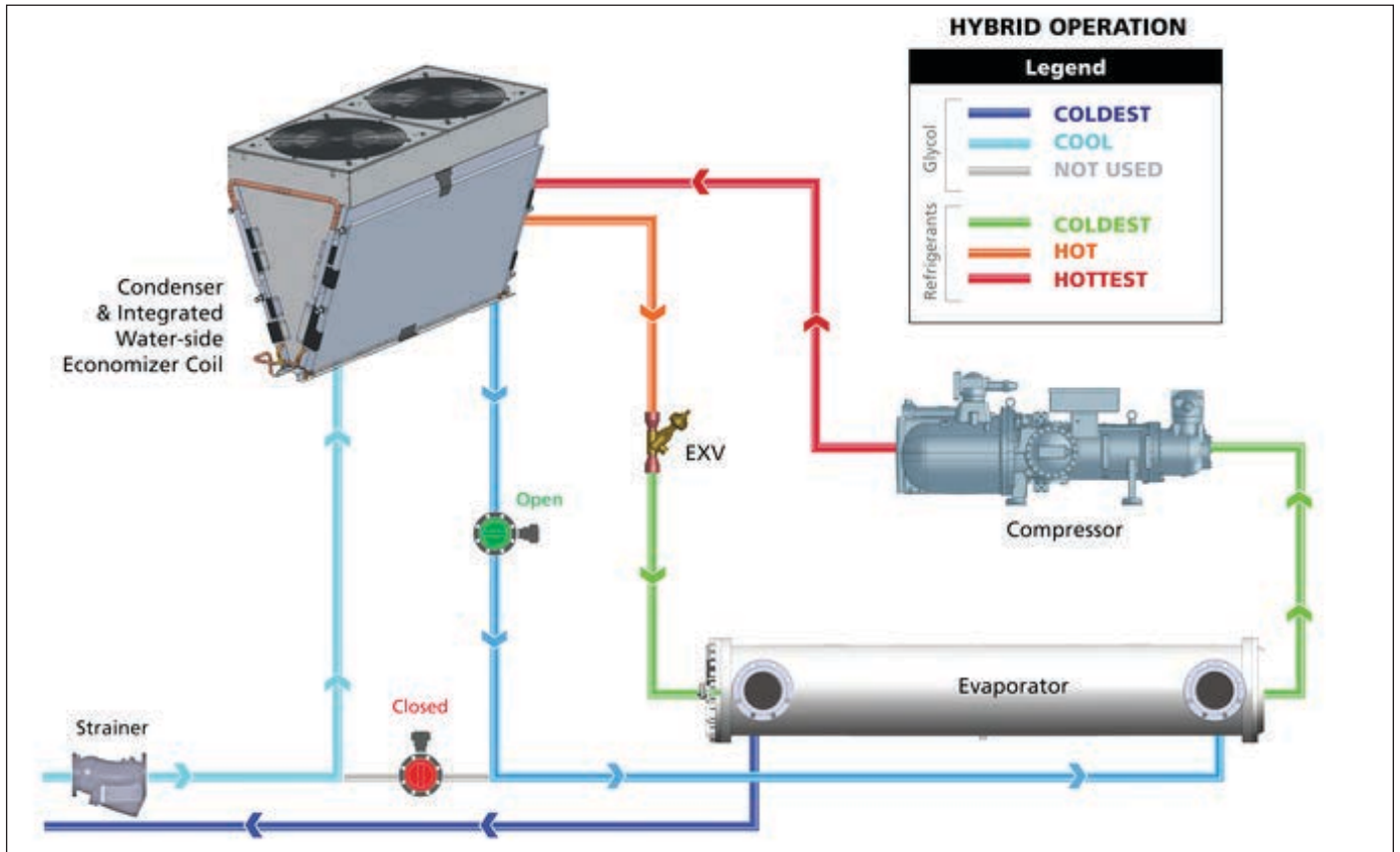

2. If the chiller is hydraulically isolated, some method of pressure relief must be added to the chiller side fluid loop such as a relief valve or expansion tank. The system must not have quick-acting valves or other sources of surge pressure in the fluid loop.
3. Maximum flow rate limits from submittal documents must be observed to protect the IWSE coils and piping.
4. A strainer for the glycol system must meet the requirements of [Inlet Strainer Guidelines](#) on page 12.
5. Inhibitors for steel, copper, brass, and aluminum must be included for all closed water loop systems. Some glycols include inhibitors and should be considered when commissioning the water system.
6. The glycol system should include a biocide to protect the system against biological growth. The biocide should be non-ionic, non-foaming, and non-oxidizing.

Figure 18: Integrated Waterside Economizer Operation

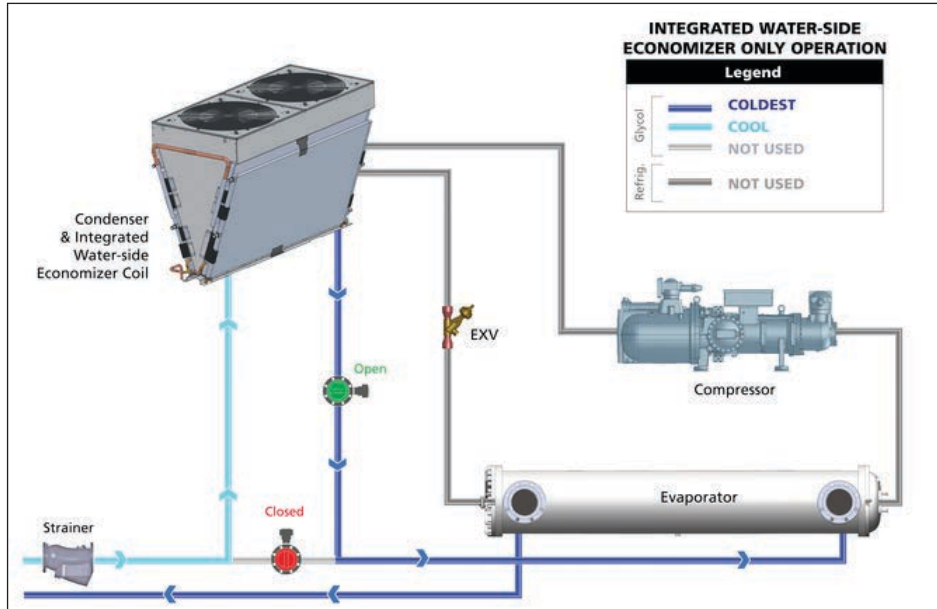
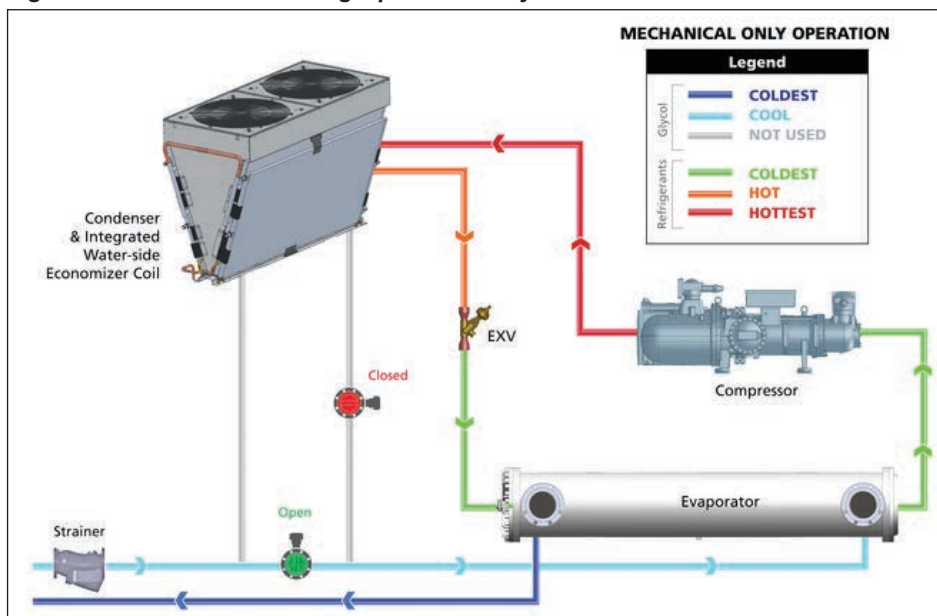

Figure 19: Mechanical Cooling Operation Only



AIR-COOLED SCREW CHILLERS

PART 1 - GENERAL

1.01 SUMMARY

- A. Section includes design, performance criteria, refrigerants, controls, and installation requirements for air-cooled rotary screw packaged chillers.

1.02 REFERENCES

- A. Comply with applicable Standards/Codes of AHRI 550/590, ANSI/ASHRAE 15, ASHRAE 90.1 current version requirements, and ASME Section VIII. ETL listed.

1.03 SUBMITTALS

- A. Submit shop drawings and product data in accordance with specification requirements.
- B. Submittals shall include the following:
 1. Dimensioned plan and elevation view drawings, required clearances, and location of all field connections.
 2. Single line schematic drawing of the field power hookup requirements, indicating all items that are furnished.
 3. If field refrigerant piping is required, furnish a single line piping drawing.
 4. Schematic diagram of control system indicating points for field connection and fully delineate field and factory wiring.
 5. Installation manuals.

1.04 QUALITY ASSURANCE

- A. Regulatory Requirements: Comply with the codes and standards specified.
- B. Factory Tested: Packaged chiller shall be pressure-tested, evacuated, and fully charged with refrigerant and oil, and be functionally run-tested at the factory.
- C. Chiller must be manufactured in an ISO certified facility.
- D. Factory trained and authorized service personnel shall perform pre-startup checks and startup procedures.

1.05 DELIVERY AND HANDLING

- A. Chillers shall be delivered to the job site completely assembled and charged with refrigerant and oil by the manufacturer.

[OPTIONAL] Remote Evaporator: The outdoor condensing unit shall be delivered to the job site completely assembled and charged with refrigerant and oil by the manufacturer. The evaporator shall

have a nitrogen holding charge and be shipped loose for field mounting, piping and charging.

- B. Comply with the manufacturer's instructions for rigging and handling.
- C. If unit is to be stored, comply with Manufacturer's instructions for storage.

1.06 WARRANTY

- A. The chiller manufacturer warranty shall cover parts and labor costs for the repair or replacement of defects in material or workmanship
 [OPTIONAL] including refrigerant for the entire unit, for a period of one year from equipment startup or 18 months from shipment, whichever occurs first,
 [OPTIONAL] and also include an additional extended warranty for (one OR two OR three OR four) years on (the entire unit) OR (on entire unit including refrigerant coverage) OR (compressor and drive train only).
 Warranty support shall be provided by company direct or factory authorized service permanently located near the job site.

1.07 SUSTAINED OPERATIONAL PERFORMANCE AND RELIABILITY

- A. [OPTIONAL]: Maintenance of the chillers in accordance with manufacturer's recommendations as published in the installation and maintenance manual shall be the responsibility of the owner.

PART 2: PRODUCTS

2.01 ACCEPTABLE MANUFACTURERS

- A. Basis of Design - Daikin Model AWV, including the standard product features and all special features required per the plans and specifications.
- B. Equal Products - Equipment manufactured by [ENTER MANUFACTURER NAME HERE] may be acceptable as an equal. Equipment proposed "as equal", must meet the specifications including all architectural, mechanical, electrical, and structural details, all scheduled performance and the job design, plans and specifications.

2.02 UNIT DESCRIPTION

- A. Provide and install as shown on the plans, factory assembled, factory charged with R-134a, and factory run-tested, air-cooled, rotary screw compressor packaged chillers in the quantity and capacity specified. Each chiller shall consist of multiple semi-hermetic screw compressors, evaporator, air-cooled condenser section, control system and all components necessary for protected and controlled unit operation.

[OPTIONAL] Remote Evaporator: Provide and install as shown on the plans, factory assembled, factory charged with R-134a, air-cooled, screw compressor outdoor condensing with matching remotely-mounted evaporator in the quantity and size specified. Each condensing unit shall consist of multiple semi-hermetic screw compressors, air-cooled condenser section, control panel and all components necessary for protected and controlled unit operation exclusive of refrigerant specialties. The remote evaporator shall be charged with nitrogen and shipped with each circuit's refrigerant specialties boxed for field installation.

2.03 DESIGN REQUIREMENTS

- A. General: Provide a complete rotary screw packaged chiller as specified and as shown on the drawings. The unit shall be in accordance with the standards referenced in section 1.02.

[OPTIONAL] General: Provide a complete rotary-screw outdoor condensing unit and separate matched remote evaporator as specified herein and as shown on the drawings. The unit shall be in

accordance with the standards referenced in section 1.02.

- B. Performance: Refer to the schedule of performance on the drawings. The chiller system shall be capable of stable minimum part load operation of 15% without hot gas bypass.

The unit shall be capable of operating to 32°F (0°C) ambient temperature.

[OPTIONAL]: The unit shall have factory mounted, low ambient head pressure control providing low ambient start capability to -10°F (-23.3°C) and operation to -20°F (-28.9°C) ambient temperatures.

- C. Acoustics: Manufacturer must provide both sound power and sound pressure data in decibels. Sound pressure data per AHRI 370 must be provided in 8 octave band format at full load. In addition, A-weighted sound pressure at 30 feet should be provided at 100%, 75%, 50% and 25% load points to identify the full operational noise envelope. Sound power must be provided in 1/8 octave band format to highlight any tonal quality issues.

If manufacturer cannot meet the noise levels (per the attached chart), sound attenuation devices and/or barrier walls must be installed to meet this performance level.

[OPTIONAL] Each compressor shall have a factory-installed, rigid, sound enclosure with removable panels for compressor access.

[OPTIONAL] The unit shall have sound attenuation material wrapped on the entire length of the discharge line.

Sound Pressure (at 30 feet)											
63 Hz	125 Hz	250 Hz	500 Hz	1K Hz	2K Hz	4K Hz	8K Hz	Overall dBA	75% Load dBA	50% Load dBA	25% Load dBA

Sound Power											
63 Hz	125 Hz	250 Hz	500 Hz	1K Hz	2K Hz	4K Hz	8K Hz	Overall dBA	75% Load dBA	50% Load dBA	25% Load dBA

2.04 CHILLER COMPONENTS

- A. Compressors:
 1. The compressors shall be field serviceable, semi-hermetic, single-rotor screw type with one central helical rotor. The gaterotor contact element shall be constructed of engineered composite material, dimensionally stable up to 1500°F and wear resistant for extended life. Compressors shall be vibration isolated from the frame by neoprene compression mounts. If a twin-screw design is used, the manufacturer shall provide an extended

5-year parts and labor warranty covering all additional moving parts.

If compressor does not have an internal discharge compressor muffler, additional sound attenuation must be provided.

[OPTIONAL]: Each compressor shall be equipped with a suction service shutoff valve.

- 2. Compressor Motors: Motors shall be high torque, two pole, semi-hermetic, squirrel cage induction type with inherent thermal protection on all three phases and cooled by suction gas.

3. Compressor Motor Control: Each compressor shall be equipped with a VFD providing compressor speed control as a function of the cooling load. Each VFD shall provide controlled motor acceleration and deceleration, and shall provide protection for the following conditions: electronic thermal overload, over/under current, stalled motor, input and output phase loss, high load current, and current unbalance. The VFD shall provide a minimum 95% displacement power factor at all load points. Compressors used in VFD controlled units must have electrically insulated, ceramic bearings to mitigate bearing and/or lubricant damage from stray electric current passage. Compressor shall be able to control compression ratio to optimize efficiency at all operating conditions. Units without this protection must have an extended 5-year compressor warranty.

- a. The unit controller shall display the following data:
 - Output Frequency
 - Output Current
 - Output Voltage
 - Output Power
 - Fault Code
 - b. The unit controller shall display the following alarms and faults:
 - Over Current-Hold
 - Over Current-Unload
 - Over Current-Alarm
 - Overheat-Hold
 - Overheat-Unload
 - Overheat-Alarm
 - Communication Fault
 - System power not three phase
 - Phase sequence incorrect
 - Line frequency less than 25 Hz
 - Line frequency more than 72 Hz
 - Excessive current unbalance
 - Operating parameters lost
 - No current after "Run" command
 - Undercurrent trip occurred
 - Overcurrent trip occurred
 - Control power too low
 - Motor stalled during acceleration
 - External fault
 - c. The unit controller shall display the following operating messages:
 - Line voltage not present
 - Voltage present, starter ready
 - Motor accelerating
- Motor at full speed
 - Motor at full speed, ramp time expired
 - Stop command received, motor decelerating
 - Thermal overload has reached 90% to 99%
 - Thermal overload at 100%, motor stopped
 - Thermal overload reduced to 60%, motor can restart
 - Passcode enabled
 - Passcode disabled
 - Thermal overload content in percentage

B. Evaporator:

Braze Plate Evaporator: The evaporator shall be a compact, high efficiency, dual circuit, brazed plate-to-plate type heat exchanger consisting of parallel stainless steel plates.

The waterside working pressure shall be a minimum of 653 psig (4502 kPa). Vent and drain connections shall be provided in the inlet and outlet chilled water piping by the installing contractor. Evaporators shall be designed and constructed according to, and listed by, Underwriters Laboratories (UL).

The evaporator shall be protected with an external, electric resistance heater plate. The evaporator shall be insulated with 3/4" (19 mm) thick CFC and HCFC-free closed-cell flexible elastomeric foam insulation material with 100% adhesive coverage. The insulation shall have an additional outer protective layer of 3mm thick PE embossed film to provide superior damage resistance. Insulation without the protective outer film shall not be acceptable. UV resistance level shall meet or exceed a rating of 'Good' in accordance with the UNI ISO 4892 - 2/94 testing method. This combination of a heater plate and insulation shall provide freeze protection down to -20°F (-29°C) ambient air temperature.

Shell and Tube Evaporator: The evaporator shall be of the direct expansion type with single pass on the refrigerant side and water side for high efficiency counterflow heat transfer and low pressure drops, carbon steel shell, and high efficiency finned copper tubes rolled into steel tube sheets. The evaporator shall be designed, inspected, and stamped in accordance with ASME Section VIII requirements. It shall be mounted and piped in the unit.

The evaporator shall be protected with an electric resistance immersion heater. The evaporator shall be insulated with 3/4" thick CFC and HCFC-free closed-cell flexible elastomeric foam insulation material with 100% adhesive coverage. The insulation shall have an additional outer protective layer of 3mm thick PE embossed film to provide superior damage resistance. Insulation without the protective outer film shall not be acceptable. UV resistance level shall

meet or exceed a rating of 'Good' in accordance with the UNI ISO 4892 - 2/94 testing method. This combination of an immersion heater and insulation shall provide freeze protection down to -20°F (-29°C) ambient air temperature.

[OPTIONAL] The evaporator shall be insulated with 1.5" (38 mm) thick CFC and HCFC-free closed-cell flexible elastomeric foam insulation material with 100% adhesive coverage.

The evaporator shall have standard left-hand grooved connections when looking at the control panel end. OR

The evaporator shall have right-hand grooved connections when looking at the control panel end.

The evaporator shall be equipped with a factory-mounted and wired flow switch.

[OPTIONAL] The evaporator is to be shipped separate from the unit for remote field installation including interconnecting refrigerant piping and wiring and have a nitrogen holding charge. Refrigerant specialties kit and flow switch shall be shipped separately with the evaporator.

C. Condenser:

1. Condenser fans shall be propeller type arranged for vertical air discharge and individually driven by direct drive fan motors. Fan motors shall be weather protected, three-phase, direct-drive, TEAO, totally enclosed air-over motors with class F insulation or better.

[OPTIONAL] The first fan motor on each circuit shall be equipped with a VFD providing fan speed control as a function of the condenser pressure.

[OPTIONAL] All fan motors on each circuit shall be ECM/DC permanent magnet type providing fan speed control as a function of the condenser pressure.

ODP motors are not acceptable. Each fan section shall be partitioned to avoid cross circulation. The fans shall be equipped with a heavy-gauge vinyl-coated fan guard. Condenser fans must be constructed of a single piece, molded composite material to provide low noise levels and protection against corrosion.

2. Coil shall be microchannel design and shall have a series of flat tubes containing multiple, parallel flow microchannels layered between the refrigerant manifolds. Tubes shall be 9153 aluminum alloy. Tubes made of 3102 alloy or other alloys of lower corrosion resistance shall not be accepted. Coils shall consist of a two-pass arrangement. Each condenser coil shall be factory leak tested with high-pressure air under water. Coils shall withstand 1000+ hour acidified synthetic sea water fog (SWAAT) test (ASTM G85-02) at 120°F (49°C) with 0% fin loss and

develop no leaks..

[OPTIONAL - Epoxy coated Micro-Channel Option]: Condenser coils shall include baked epoxy coating providing 10,000+ hour salt spray resistance (ASTM B117-90).

[OPTIONAL - Integrated Waterside Economizer Option]: Include waterside coils capable of rejecting 100% of the cooling load at or below the specified integrated waterside economizer ambient temperature. Chiller shall include 3 modes of operation: mechanical cooling only, combination mechanical and economizer operation (hybrid mode), and integral economizer only operation. Chiller shall automatically control selection of modes to ensure optimal efficiency. Include two 2-way control valves to automatically bring economizer in or out of the loop, bypassing the economizer during mechanical operation to avoid economizer coil pressure drop.

Integrated economizer coil shall be microchannel design and shall have a series of flat tubes containing multiple, parallel flow microchannels layered between the header manifolds. Header manifolds of each coils shall have 2 inlets and 2 outlets to minimize pressure drop. Tubes shall be 9153 aluminum alloy. Tubes made of 3102 alloy or other alloys of lower corrosion resistance shall not be accepted. Each economizer coil shall be factory leak tested with high-pressure air under water. Coils shall withstand 1000+ hour acidified synthetic sea water fog (SWAAT) test (ASTM G85-02) at 120°F (49°C) with 0% fin loss and develop no leaks.

[OPTIONAL Epoxy Coating for Economizer Coils]: Economizer coils shall include baked epoxy coating providing 10,000+ hour salt spray resistance (ASTM B117-90).

Include factory-provided strainer of sufficient mesh size to provide protection to the microchannel economizer coils, installed by the contractor at the chiller fluid piping inlet. Field-provided strainers shall not be acceptable.

- D. Refrigerant Circuit: The unit must have refrigerant circuits completely independent of each other with one compressor per circuit; multiple per circuit shall not be acceptable. Each circuit shall include an electronic expansion valve, liquid line shut-off valve, replaceable core filter-drier, sight glass with moisture indicator, and combination discharge check and shutoff valve.

[OPTIONAL] Unit shall be equipped with a liquid line solenoid valve.

- E. Unit formed sheet metal components shall be painted using a corrosion resistant paint system, for aesthetics and long-term durability. Paint system will include a base primer with a high-quality polyester

resin topcoat. Painted galvanized parts shall be G60 or greater and finished, unabraded panel surfaces shall be capable to be exposed to an ASTM B117 salt spray environment and exhibit no visible red rust at a minimum of 3,000 hours exposure. Finished, abraded surfaces shall be tested per ASTM D1654, having a mean scribe creepage not exceeding 1/16" at 1,000 hours minimum exposure to an ASTM B117 salt spray environment. The control enclosure and unit panels shall be corrosion resistant painted before assembly. Unit shall have condenser coil grilles. OR

[OPTIONAL] Unit shall have condenser coil grilles and base frame grilles. OR

[OPTIONAL] Unit shall have condenser coil louvers and base frame grilles. OR

[OPTIONAL] Unit shall have condenser coil louvers only. OR

[OPTIONAL] Unit shall have condenser coil grilles and base frame grilles. OR

[OPTIONAL] Unit shall have condenser coil louvers and base frame louvers.

[OPTIONAL] Unit shall have condenser coil louvers placed on the end of the unit only.

[OPTIONAL] Neoprene-in-shear vibration isolators shall be furnished for field installation at time of unit placement. OR

[OPTIONAL] Spring isolators shall be furnished for field installation at time of unit placement.

[OPTIONAL] Wind Load Rated: Tested and rated to withstand wind speeds up to 181 mph. Provide engineer-stamped certificate that equipment has been evaluated and built to meet the required wind velocity.

F. Electrical Panel:

1. A centrally located, UL-approved weatherproof electrical control panel shall contain the unit control system, control interlock terminals and field-power connection points. Box shall be designed in accordance with NEMA 3R rating. Hinged control panel access doors shall be tool-lockable. Barrier panels shall be factory mounted to protect against accidental contact with line voltage when accessing the control system.
2. Power Section: Power supply shall be single-point to factory-mounted disconnect switch with through-the-door handle and circuit breakers. OR

[OPTIONAL]: Power supply shall be multi-point power to factory-mounted disconnect switches with through-the-door handles for each compressor circuit, no circuit breakers. OR

[OPTIONAL]: Power supply shall be single-point power to factory-mounted power block and circuit

breakers. OR

[OPTIONAL]: Power supply shall be to a high short-circuit current rated panel with a single-point high interrupting capacity unit disconnect switch breakers for each circuit. OR

[OPTIONAL]: Power supply shall be multi-point connections to high short-circuit current rated panel. Include two (or three) high interrupting capacity disconnect switches and no circuit breakers.

Fan motors shall have inherent overload protection and compressor motors shall have three-phase motor overload protection. Factory-supplied power components shall include individual contactors and circuit breakers for fan motors, circuit breakers and factory-mounted transformers for each control circuit.

[OPTIONAL] A 10.0 amp, 115-volt convenience outlet shall be mounted inside the control panel on all 60Hz units.

3. Control Section: The control logic shall be designed to maximize operating efficiency and equipment life with protections for operation under unusual conditions and to provide a history of operating conditions. The system shall intelligently stage the unit to sustain leaving water temperature precision and stability while minimizing compressor cycling.

Equipment protection functions controlled by the microprocessor shall include high discharge pressure, loss of refrigerant, loss of water flow, freeze protection, and low refrigerant pressure.

User controls shall include auto/stop switch, chilled water set-point adjustment, anti-recycle timer, and digital display with water temperature setpoint, operating temperatures and pressures, and diagnostic messages.

The following features and functions shall be included:

- a. Durable liquid crystal display (LCD) screen type, having minimum four 20-character lines with 6 key input pad conveniently mounted on the unit controller. Default language and units of measure shall be English and IP respectively. Messages shall be in plain English. Coded messages, LED indicators and LED displays are not acceptable.
- b. Separate control section and password protection for critical parameters.
- c. Remote reset of chilled water temperature using a 4-20mA signal.
- d. Soft-load operation, protecting the compressor by preventing full-load operation during the initial chilled fluid pull-down period.

- e. Non-volatile program memory allowing auto-restart after a power failure.
- f. Recording of safety shutdowns, including date-and-time stamp, system temperatures and pressures. A minimum of six previous occurrences shall be maintained in a revolving memory.
- g. Start-to-start and stop-to-start cycle , giving minimum compressor off time and maximizing motor protection.
- h. Lead-lag compressor staging for part-load operation by manual selection or automatically by circuit run hours.
- i. Discharge pressure control through intelligent cycling of condenser fans to maximize efficiency [OR variable speed control of condenser fans].
- j. Pro-active compressor unloading when selected operating parameters exceed design settings, such as high discharge pressure or low evaporator pressure.
- k. Diagnostic monitoring of unit operation, providing a pre-alarm signal in advance of a potential shutdown, allowing time for corrective action.

[OPTIONAL]: The factory-mounted DDC controller shall support BAS operation via Open Choices™ standard protocols using either BACnet MS/TP, BACnet IP or BACnet or LonMark. The information communicated between the BAS and the factory mounted unit controllers shall include the reading and writing of data to allow unit monitoring, control and alarm notification as specified in the unit sequence of operation and the unit points list.

[OPTIONAL]: The unit shall be equipped with a RapidRestore® feature to restart a unit within 35 seconds of power interruption and a Fast Loading feature to minimize the time to restore full load operation.

[OPTIONAL] The unit shall be equipped with an emergency stop button on the control panel door.

[OPTIONAL]: The unit shall be equipped with ground fault protection.

[OPTIONAL]: The unit shall be equipped with a Remote User Display allowing full unit control and user input. Remote User Display shall be capable of providing remote control for eight (8) chillers.

documents.

- B. Measures must be taken to avoid accumulation of debris in the evaporator during initial system flushing. A strainer with perforation no larger than 0.063" (1.6 mm) diameter for braze plate evaporators or with perforation no larger than 0.125" (3.2 mm) diameter for shell and tube evaporators must be placed in the supply water line just prior to the inlet of the evaporator.

Care shall be exercised when welding pipe or flanges to the evaporator to prevent any slag from entering the vessel. Any welds after the strainer must be mechanically cleaned to avoid slag entering the evaporator.

- C. Adjust and level chiller in alignment on supports.
- D. Coordinate electrical installation with electrical contractor.
- E. Coordinate controls with control contractor.
- F. Provide all required accessories or accompanying parts to insure a fully operational and functional chiller.

3.02 STARTUP

- A. Provide Factory Authorized starting of chillers, and instruction to the owner on operation and maintenance.

PART 3 - EXECUTION

3.01 INSTALLATION

- A. Install in strict accordance with manufacturer's requirements, shop drawings, and contract



Daikin Applied Training and Development

Now that you have made an investment in modern, efficient Daikin Applied equipment, its care should be a high priority. For training information on all Daikin Applied HVAC products, please visit us at www.DaikinApplied.com and click on Training, or call 540-248-9646 and ask for the Training Department.

Warranty

All Daikin Applied equipment is sold pursuant to its standard terms and conditions of sale, including Limited Product Warranty. Consult your local Daikin Applied representative for warranty details. To find your local Daikin Applied representative, go to www.DaikinApplied.com.

Aftermarket Services

To find your local parts office, visit www.DaikinApplied.com or call 800-37PARTS (800-377-2787). To find your local service office, visit www.DaikinApplied.com or call 800-432-1342.

This document contains the most current product information as of this printing. For the most up-to-date product information, please go to www.DaikinApplied.com.

Products manufactured in an ISO Certified Facility.